

WINE LIVING

'24 Collection



DELLA MARTA
ITALY

Designer



Massimo Della Marta
Designer & Founder

Visionario, coinvolgente, poliedrico, appassionato di arte e con un amore, grande, per l'armonia che genera bellezza.

Forte di una non comune sensibilità, una brillante curiosità e un'abilità espressiva, ha raggiunto una sua originalità che esprime attraverso la progettazione di oggetti di design senza tempo. Un'eccellenza del new life style.

"Cerco in ogni forma l'essenza, e il suo senso intrinseco. Mi concentro e rifletto sui tanti aspetti che un oggetto può comunicare. Funzione, simbolo, valore, sono concetti che si fondono generando l'espressione identitaria di una creazione. Il design non è arte, è parte dell'arte di vivere".

Sommelier per passione, ha disegnato una collezione di vetrine climatizzate di assoluta avanguardia tecnologica ed estetica, tra cui la Teca e l'iconico Quadro Vino. Oggetti fortemente identitari che hanno reso il brand conosciuto ed apprezzato in tutto il mondo.

Brevetti di portata internazionale, tra cui il rivoluzionario impianto di refrigerazione centrale, confermano la sua competenza anche nel campo dell'ingegneria meccanica e termodinamica.

"Ho lavorato duramente per raggiungere il mio obiettivo di legare la tecnologia al design e colpire il cuore delle emozioni".

Legato a valori unici come etica, ecologia e sostenibilità, progetta, sviluppa ed ingegnerizza, le sue creazioni, interpretando un'estetica contemporanea e ponendo particolare attenzione all'intera vita del prodotto.

Visionary, engaging, multifaceted, passionate about art and with a great love for the harmony which generates beauty.

Strengthened by an uncommon sensitivity, a brilliant curiosity and an expressive ability, he has achieved his own originality that he expresses through the design of timeless design objects. Excellence of the new lifestyle.

"I seek essence in every form and its intrinsic sense". I focus and reflect on the many aspects which an object can communicate. Function, symbol and value, are concepts which come together generating the identity expression of a creation. Design is not art, it is part of the art of living".

A sommelier through passion, he designed a collection of technological and aesthetic state-of-the-art air-conditioned display cases, including the Teca and the iconic Quadro Vino. Strongly identifying objects that have made the brand known and appreciated worldwide.

International patents, including the revolutionary central refrigeration system, confirm his expertise also in the field of mechanical engineering and thermodynamics.

"I've worked hard to achieve my goal of linking technology to design and hitting the heart of emotions".

Linked to unique values such as ethics, ecology and sustainability, he designs, develops and engineers his creations, interpreting a contemporary aesthetic and paying particular attention to the entire life of the product.

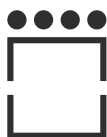

Index

Collezione Wine Living

Quadro Vino

Quadro Vino n. 12 Pag. 12

Quadro Vino n. 30 Pag. 16

Quadro Vino n. 40 Pag. 18

Quadro Vino n. 52 Pag. 20

Expo M12

Expo M12 Pag. 24

Teca

Teca Pag. 34

Teca B Pag. 38

Mod

Mod 10 Pag. 44

Mod 20 Pag. 56

Arka

Arka Pag. 66

Area tecnica e listino prezzi

Technical area and price list • Domaine technique et liste des prix Pag. 71

Optional Pag. 116

Cartella colori

Colour chart • Nuancier Pag. 124

Legenda

Legend • Légende Pag. 126

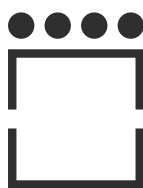

DELLA MARTA

Collezione Wine Living®

Ricerca ed innovativa, la collezione di vetrine climatizzate per il vino Wine Living rappresenta quanto di più rivoluzionario sia mai stato ideato nel seducente mondo degli appassionati di vino. Sono oggetti dal concept e design inconfondibile, trasformati negli anni in veri e propri simboli e destinati a diventare preziose icone senza tempo.

La collezione Wine Living è stata disegnata da Massimo Della Marta, designer e grande appassionato di vino, ispirato da una visione completamente nuova.

La vetrina del vino non è più inserita nella cucina ma è integrata nello spazio living, luogo per eccellenza riservato al relax, al piacere della compagnia ed alla convivialità.

La visione del designer si è dimostrata vincente, anticipando il trend del futuro e delineando quella che sarebbe diventata l'identità del brand.

Per la prima volta, le cantine climatizzate per il vino, da funzionali strumenti di uso domestico sono raffinati complementi di arredo, che si integrano in modo armonico e con eleganza in qualsiasi ambiente.

L'eccellente qualità che l'azienda propone da sempre è ottenuta applicando un sistema di produzione che prevede congiuntamente processi produttivi industriali e lavorazioni artigianali. Ogni prodotto viene costruito da tecnici specializzati utilizzando materie prime e semilavorati di altissima qualità e ponendo particolare cura per ogni dettaglio.

La collezione Wine Living è realizzata interamente in Italia, negli stabilimenti Della Marta alle porte di Torino.

Scelte dai più grandi Sommelier e Chef a livello internazionale, le cantine climatizzate Della Marta hanno varcato le dimore del mondo e fanno parte del life style dei wine lovers ovunque.

Sophisticated and ground-breaking, climate wine cabinet collection Wine Living is a revolution in the enticing world of wine enthusiasts.

Unique by concept and design, through the years they have become a symbol destined to become timeless, precious icons.

The Wine Living collection is designed by Massimo Della Marta, designer and wine enthusiast, inspired by a brand new vision.

The wine cabinet is no longer placed in the kitchen; it is now integrated in the living area – a space devoted to relax, conviviality and sociability.

The designer's vision was a winner, having foreseen future trends and outlining what was to become a very own brand identity.

For the first time, climate wine cellars, from functional home appliances, become sophisticated pieces of furniture that gracefully and elegantly integrate in any ambience.

The company's everlasting commitment to excellence in quality is achieved through a production system that combines industrial production processes and craftsmanship.

Each product is made by specialised technicians, employing prime materials and semi-finished products of the highest quality, with painstaking attention to detail.

The Wine Living collection is entirely made in Italy, at the Della Marta premises just outside Turin.

Chosen by the greatest international Sommeliers and Chefs, Della Marta climate cabinets have entered the homes of the world and are part of wine lovers' lifestyle everywhere.



Quadro Vino



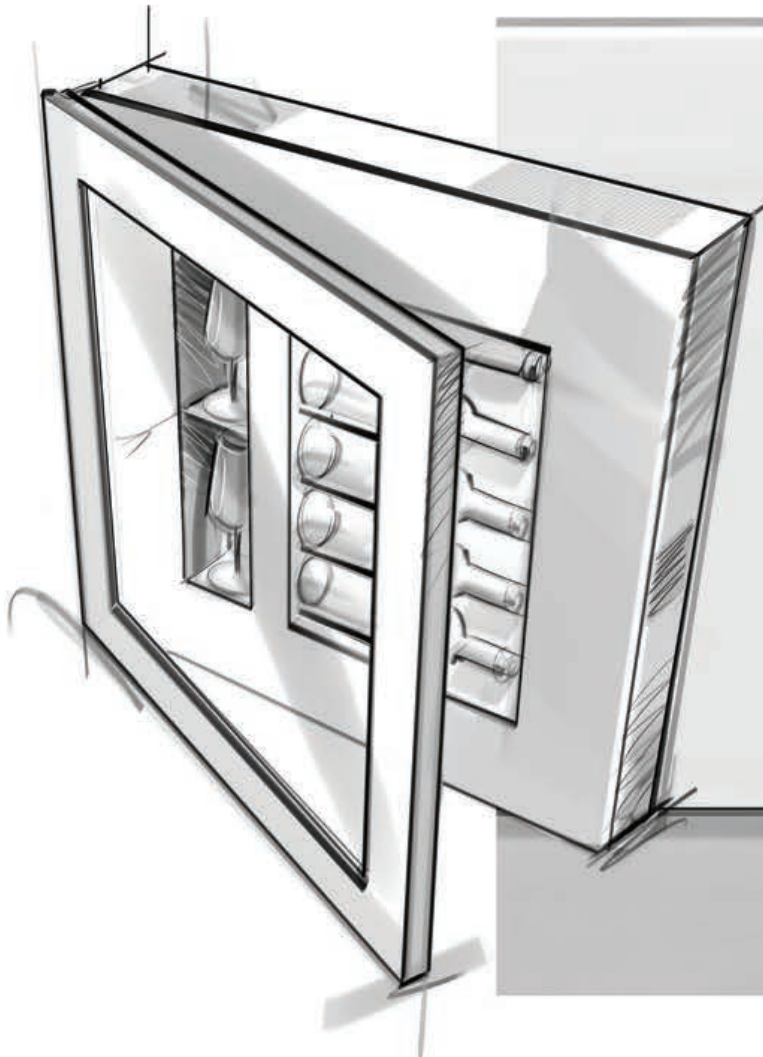

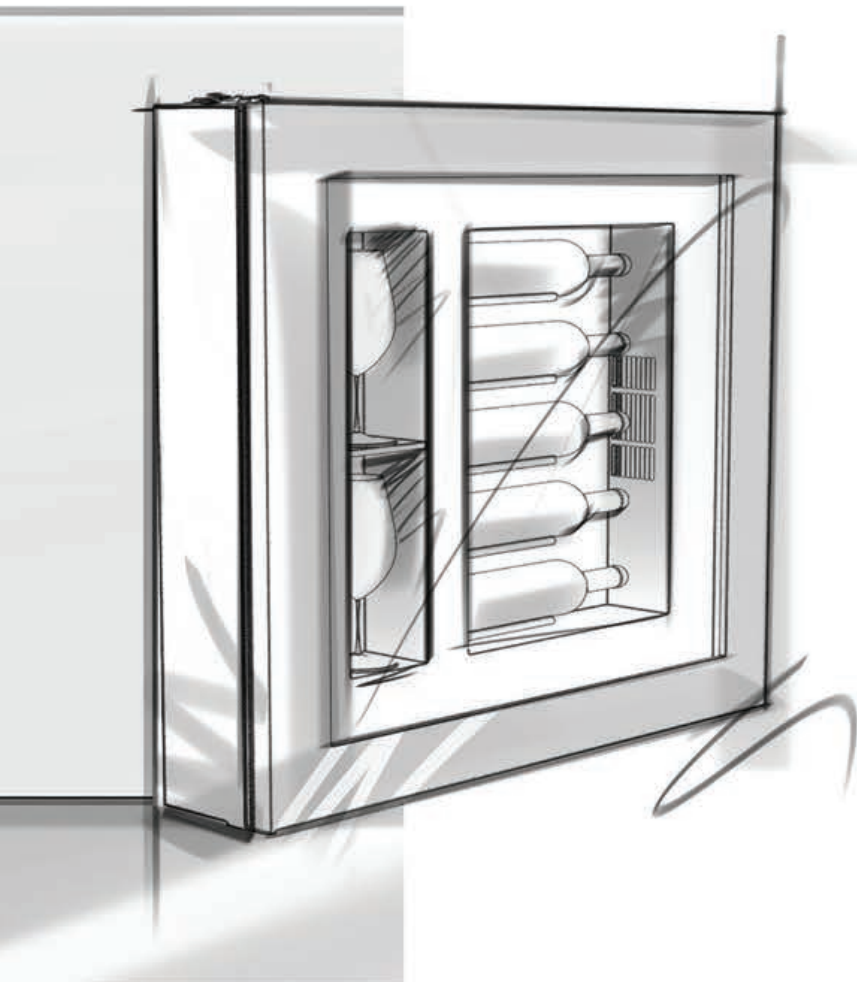

Q

Quadro Vino

Design e tecnologia si fondono per dar vita al primo quadro refrigerato mai realizzato al mondo.

Un complemento di arredo dal design inconfondibile che permette di esporre con classe le bottiglie più importanti, impreziosire e valorizzare l'ambiente che lo ospita.

Quadro Vino il primo frigorifero al mondo che, come un quadro, può essere appeso sopra un divano.

È capace di rendere speciali i momenti più importanti e regalare emozioni inaspettate.

Design and technology come together to bring to life the first refrigerated picture frame in the world.

A piece of furniture of unique design which can elegantly display the most important bottles, while enhancing and enriching the space.

Quadro Vino is the first refrigerator in the world that – just like a painting – can be hung over a sofa.

It can make the most extraordinary moments very special, and raise unexpected excitement.





Quadro Vino n. 12



QV12

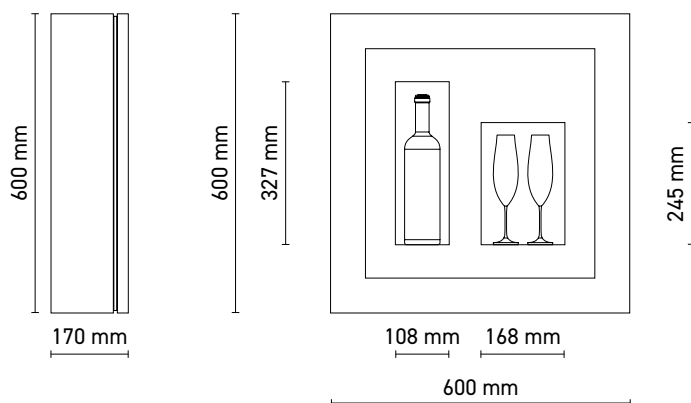

+4 / +10





Quadro Vino n. 30

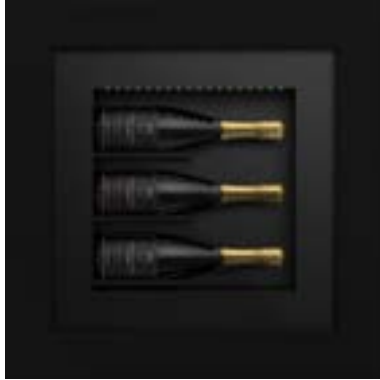

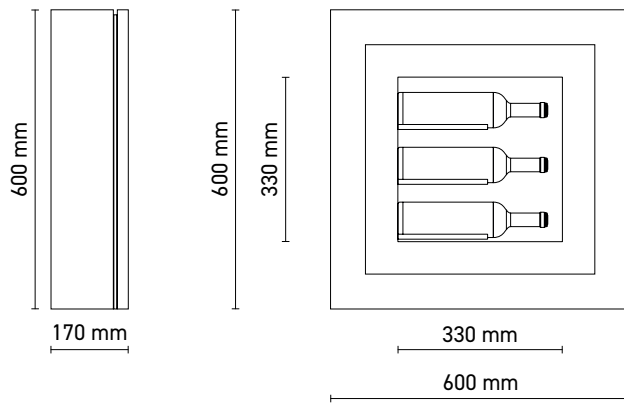

QV30



 °C
+ 8 / +20



Quadro Vino n. 30



Quadro Vino n. 40



QV40

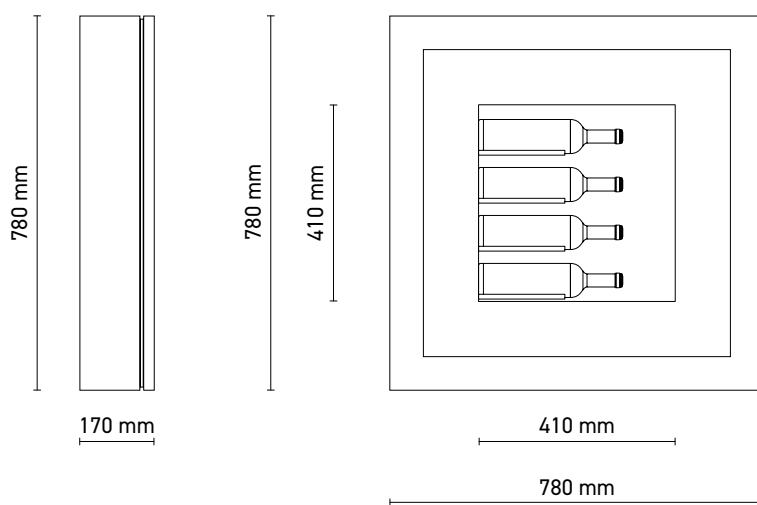

 °C
+ 12 / +20



Quadro Vino n. 52



QV52

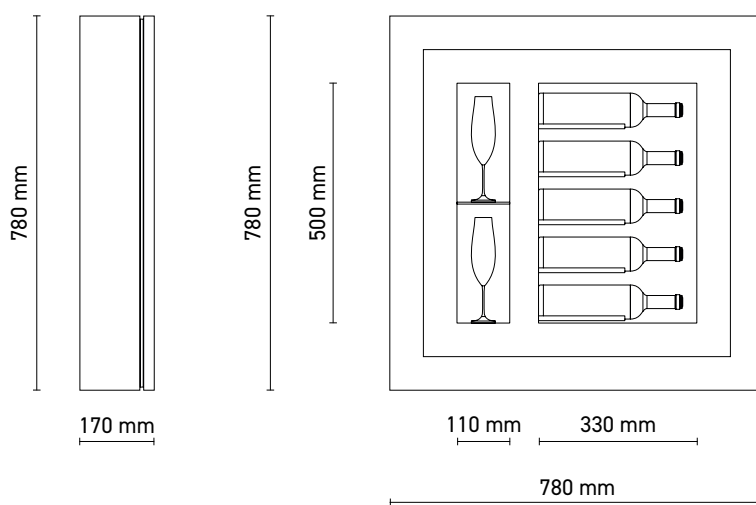

 °C
+ 12 / +20



Emme 12





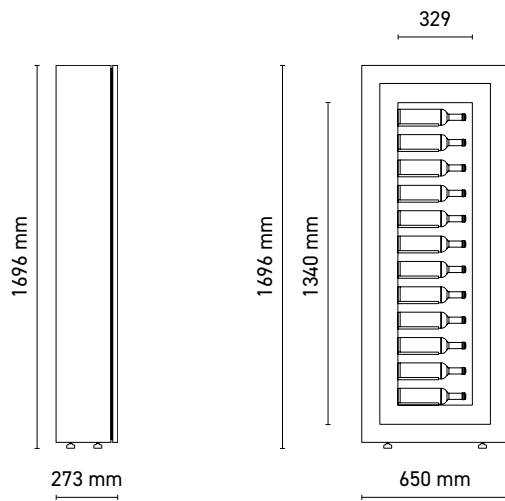

EM-12

mm		 °C
650 x 273 x 1696	12	+5 / +18





EM-12G

mm		 °C
650 x 273 x 1696	8	+5 / +18

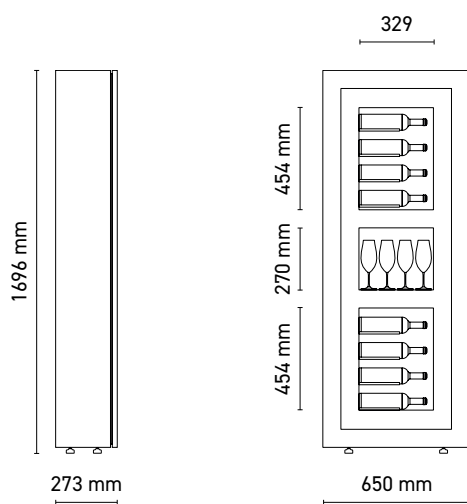

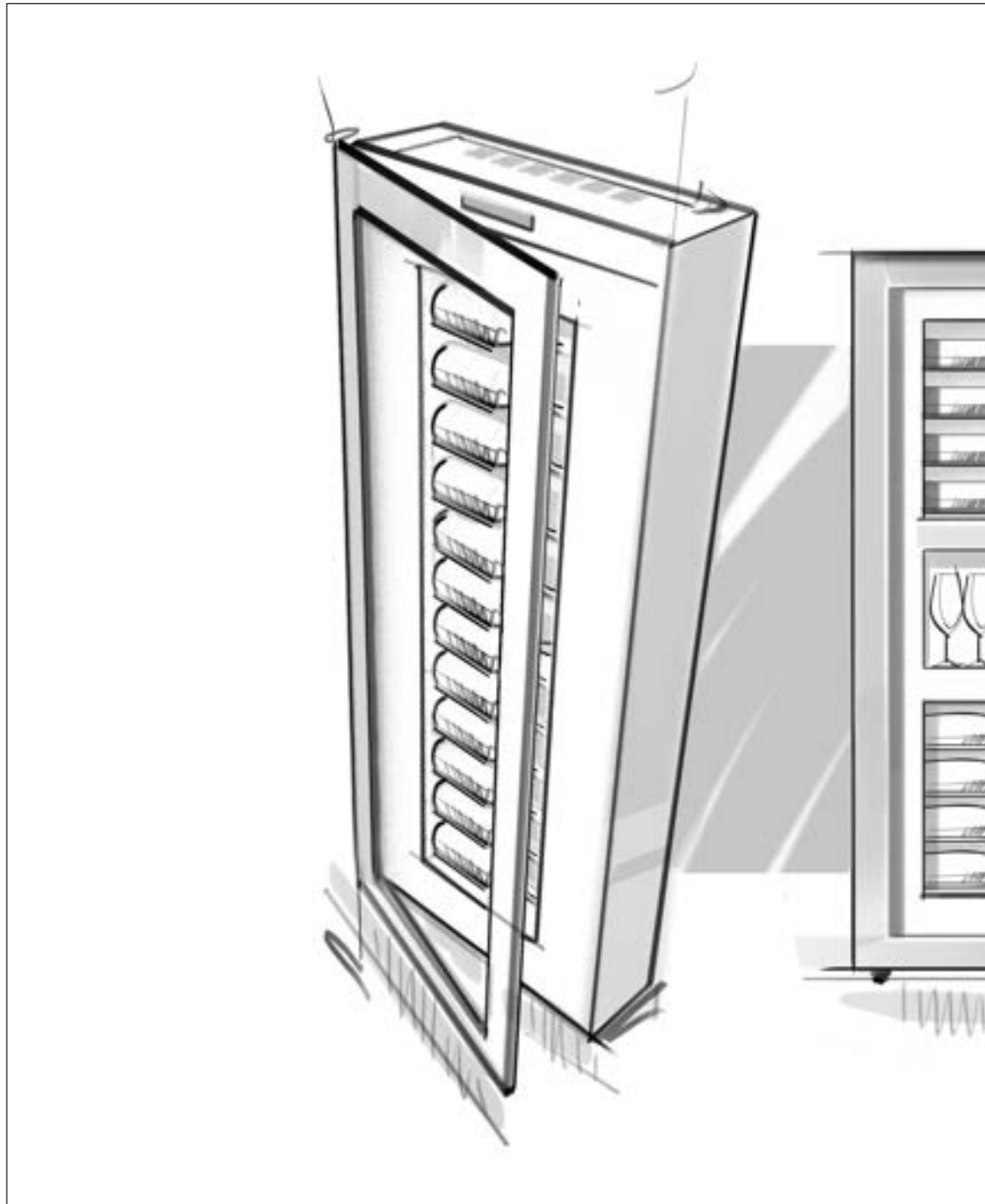

La Emme12 rappresenta la sintesi della vision del brand.
È in assoluto la vetrina per vino meno profonda al mondo.

Emme 12

La Emme12 rappresenta la sintesi della vision del brand. Oggetto fortemente identitario segue il concept estetico della collezione Quadro Vino, facendo propria una tecnologia del freddo professionale. È in assoluto la vetrina per vino meno profonda al mondo. Le temperature differenziate consentono di conservare contemporaneamente sia vini bianchi che vini rossi.

Emme 12 represents a synthesis of the brand's vision. As a highly identitary object, it follows Quadro Vino's aesthetic concept, taking up technology from professional refrigeration. It is the world's slimmest wine cabinet. Differentiated temperatures allow for conservation of white and red wines at the same time.

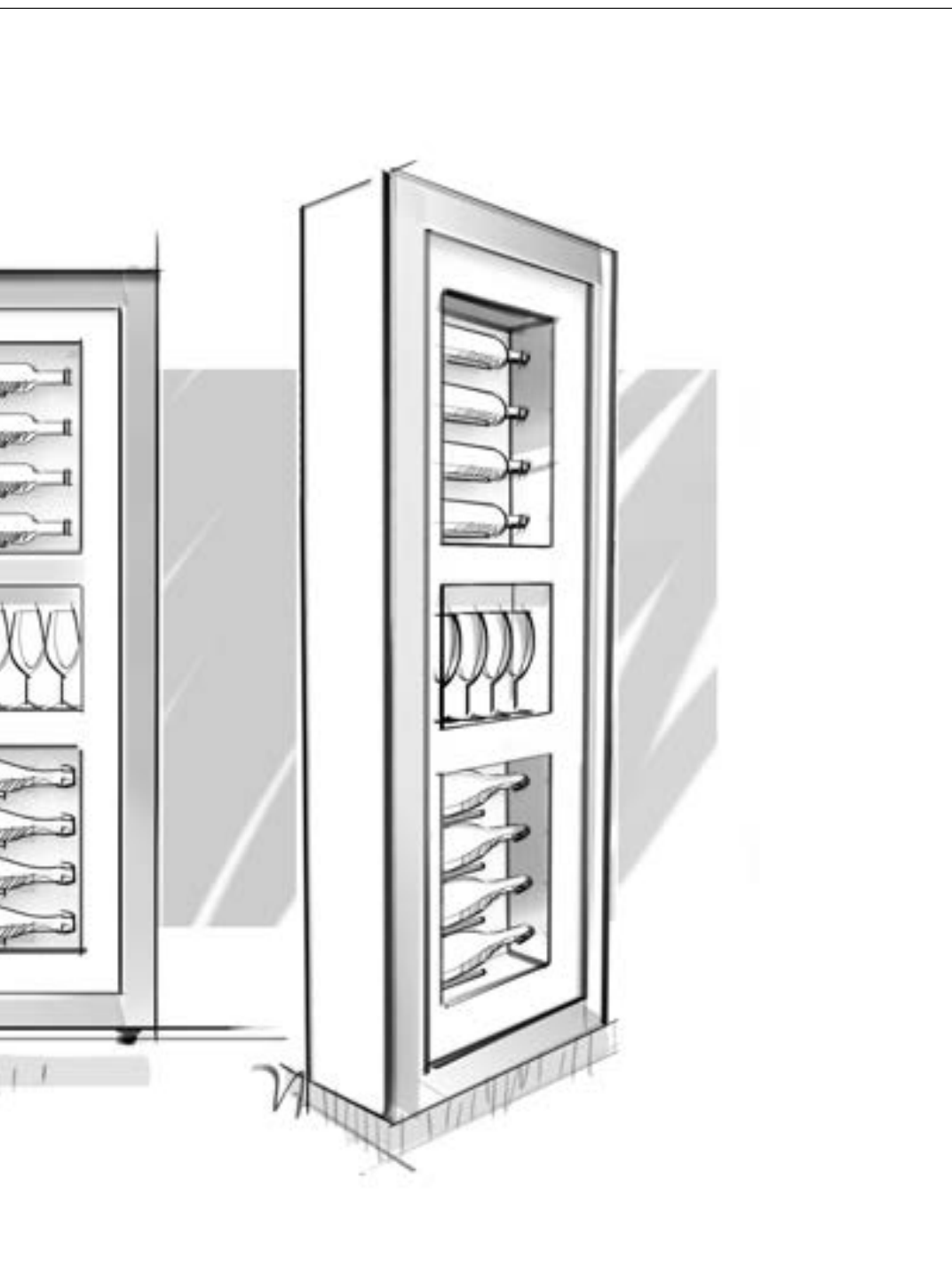



Teca



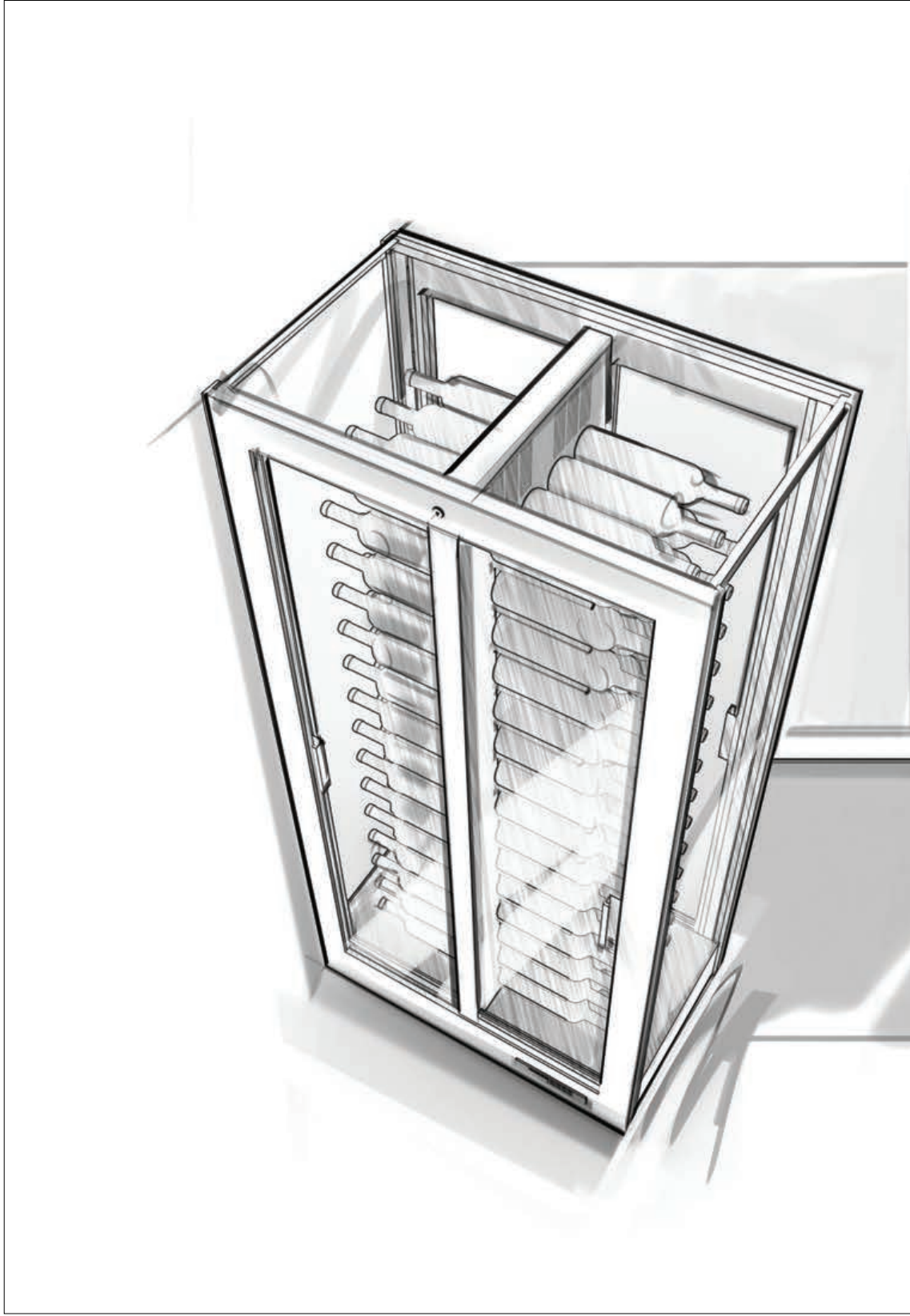

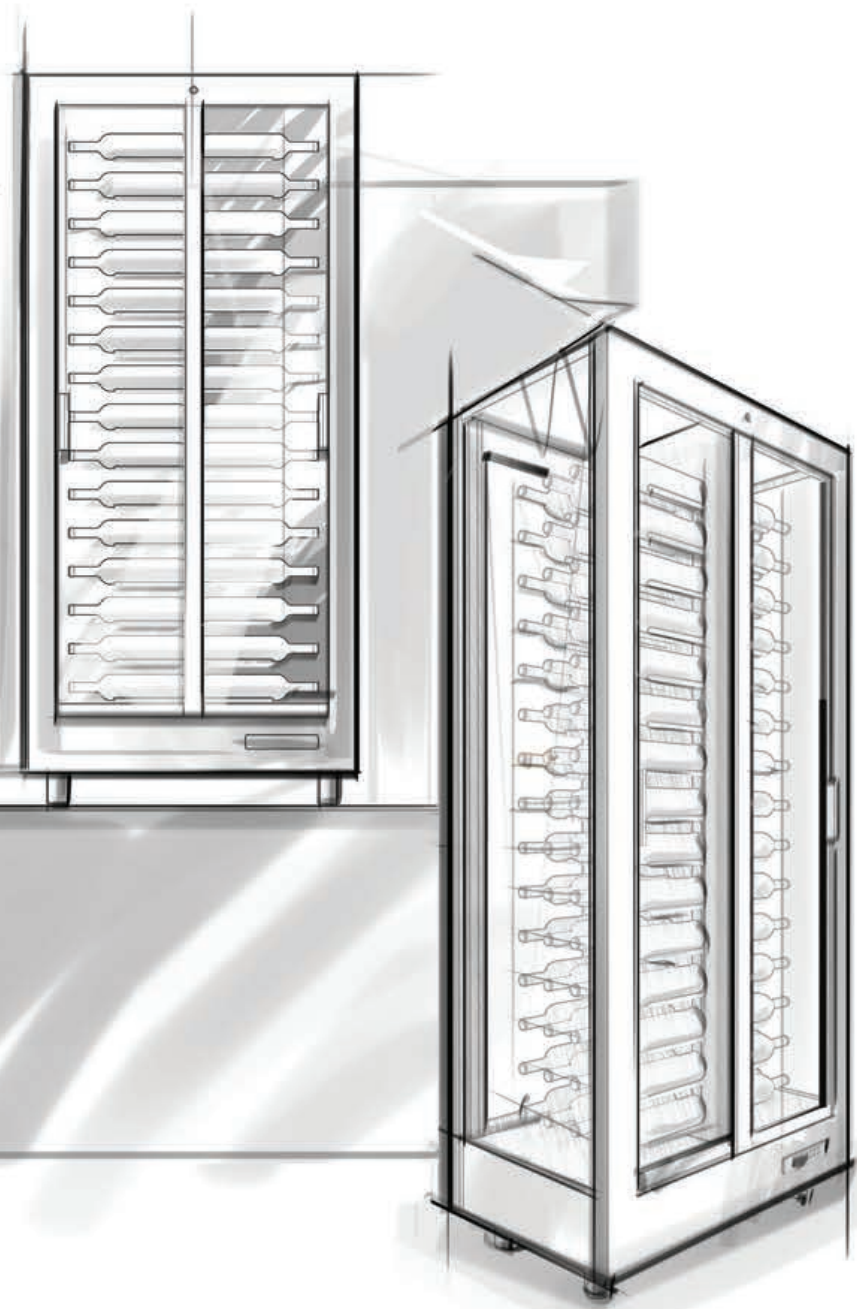

Q



Teca

La Teca si presenta sobria ed elegante, volutamente minimalista ed essenziale.

L'ampia superficie vetrata mette in risalto l'originale esposizione orizzontale delle bottiglie, creando una suggestiva scenografia.

L'impianto di refrigerazione non altera gli equilibri estetici, si integra in modo discreto e, come per magia, assume la forma di un elegante portabottiglie.

La Teca è la punta di diamante della collezione Wine living diventata icona del brand Expo nel mondo.

Teca is sober and elegant, deliberately minimalistic and essential.

Its broad glass surface emphasizes the original horizontal bottle display, creating a suggestive scene.

The refrigeration system does not alter its aesthetic balance, it integrates discreetly and – with a touch of magic – turns into an elegant bottle holder.

Teca is the most valued asset of the Wine Living collection, an Expo brand global icon.







 +5 / +18

Free standing

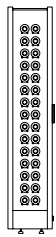
Built in

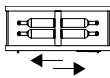

388



mm
874 x 388 x 1865

TE-H10



60



388

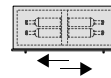

mm
874 x 388 x 1865

TBE-H10



60

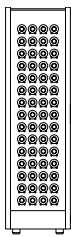

568

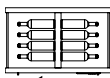

mm
874 x 568 x 1865

TE-M10



120



557

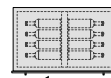

mm
874 x 557 x 1865

TBE-M10



120

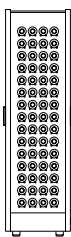

568

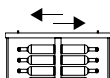

mm
874 x 568 x 1865

TE-C10



120



568

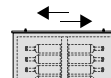

mm
874 x 568 x 1865

TBE-C10



120



°C
+5 / +18

Free standing

Built in

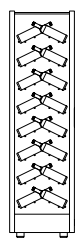

568

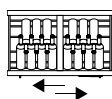

mm
874 x 568 x 1865

TE-M12



112

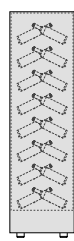

557

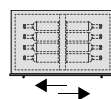

mm
874 x 557 x 1865

TBE-M12



112

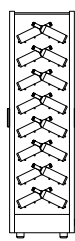

568

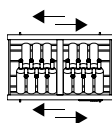

mm
874 x 568 x 1865

TE-C12



112

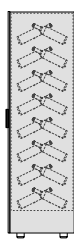

568

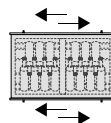

mm
874 x 568 x 1865

TBE-C12



112



Teca B





 °C
 +5 / +18

Free standing

Built in

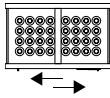
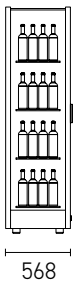

TE-M13

568

874 x 568 x 1865

128

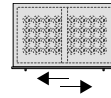
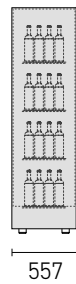

TBE-M13

557

874 x 557 x 1865

128

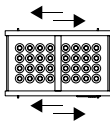
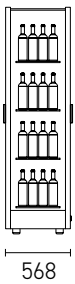

TE-C13

568

874 x 568 x 1865

128

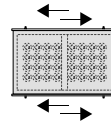
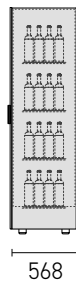

TBE-C13

568

874 x 568 x 1865

128

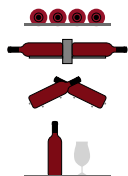

Allestimento interno personalizzabile
Custom internal layout



°C
+5 / +18

Free standing

Built in



388

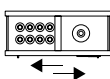

mm
874 x 388 x 1865

TE-H14



56 / 64



388

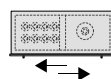

mm
874 x 388 x 1865

TBE-H14



56 / 64

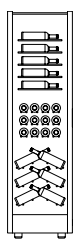

568

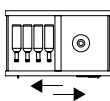

mm
874 x 568 x 1865

TE-M14



112 / 128



557

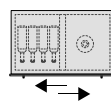

mm
874 x 557 x 1865

TBE-M14



112 / 128

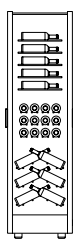

568

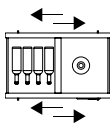

mm
874 x 568 x 1865

TE-C14



112 / 128



568

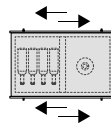

mm
874 x 568 x 1865

TBE-C14



112 / 128



Teca B





Mod 10





 °C
 +4 / +18



363

MD-H10

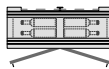

mm

900 x 363 x 1858



60



515

MD-M10

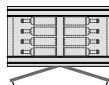

mm

900 x 515 x 1858



120



520

MD-C10

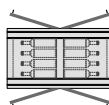

mm

900 x 520 x 1858



120



°C
+4 / +18



MD-M12

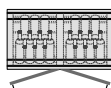

mm



515

900 x 515 x 1858

112

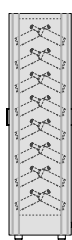

MD-C12

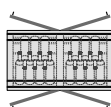

mm



520

900 x 520 x 1858

112



°C
+4 / +18

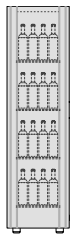

515

MD-M13

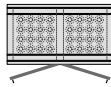

mm

900 x 515 x 1858



128

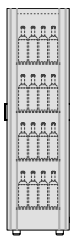

520

MD-C13

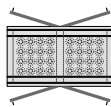

mm

900 x 520 x 1858



128

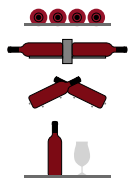

Allestimento interno personalizzabile
Custom internal layout



°C
+4 / +18



363

MD-H14

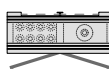

mm

900 x 363 x 1858



56/64



515

MD-M14

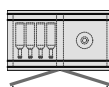

mm

900 x 515 x 1858



112/128



520

MD-C14

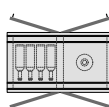

mm

900 x 520 x 1858



112/128



Mod 10



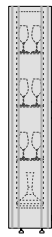

363

MD-H1-01

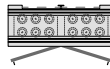

mm

900 x 363 x 1858

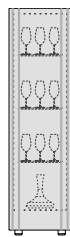

515

MD-M1-01

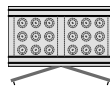

mm

900 x 515 x 1858



520

MD-C1-01

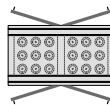

mm

900 x 520 x 1858



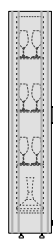

363

MD-H1-02



mm



486 x 363 x 1858

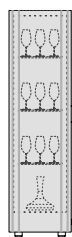

515

MD-M1-02



mm



486 x 515 x 1858



520

MD-C1-02



mm



486 x 520 x 1858



Mod 10

Sistema componibile. Una ricca collezione di finiture e colori consente di realizzare ambientazioni originali ed esclusive. Mod è tecnologia, tecnica ed applicazione al servizio del design e dell'architettura in una vision di libera espressione estetica.

Modular system. A rich collection of finishes and colours to create unique and exclusive ambiances.

Mod is technology, craft, and application at design's service, in a vision of free aesthetic expression.



FINISHES

CORNICE LINEARE

Plain frame



FN-CL

COLORS

L01 - L10 - L11 - L20 - L21 - L22 - L23 - L30
L40 - L42 - L50 - L51 - L52 - L53 - LM01 - LM02 - RAL

CORNICE SAGOMATA

Moulded frame

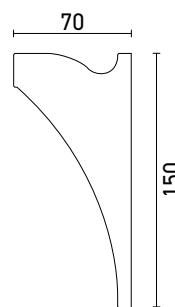

FN-CS

COLORS

A01 - LM01 - LM02 - RAL

PANNELLI LATERALI

Side panels



FN-PL

L'inserimento dei pannelli laterali è da prevedere esclusivamente nell'installazione "da appoggio" oppure "centrale".

Side panels are to be added exclusively in the case of "wall-back" or "central" installations.

COLORS

L01 - L10 - L11 - L20 - L21 - L22 - L23 - L30
L40 - L42 - L50 - L51 - L52 - L53 - LM01 - LM02 - RAL

RIVESTIMENTO FIT

Fit cladding

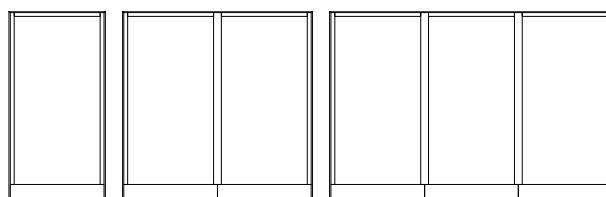

FN-RF*1A

FN-RF*2A

FN-RF*3A

Rivestimento completo top, fianchi e frontalino.
Complete cladding for top, sides and front flap.

COLORS

L01 - L10 - L11 - L20 - L21 - L22 - L23 - L30
L40 - L42 - L50 - L51 - L52 - L53 - LM01 - LM02 - RAL



Mod 20



Mod 20



 °C
 +4 / +18

MD-H20



363

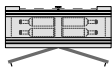

mm

900 x 363 x 903



24

MD-M20



515

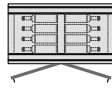

mm

900 x 515 x 903



48

MD-C20



520

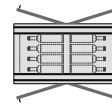

mm

900 x 520 x 903



48



 °C
 +4 / +18

MD-M22



515

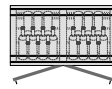

mm

900 x 515 x 903



42

MD-C22



520

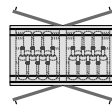

mm

900 x 520 x 903



42



°C
+4 / +18

MD-M23

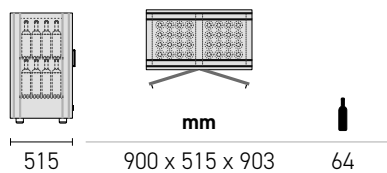

MD-C23

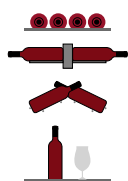
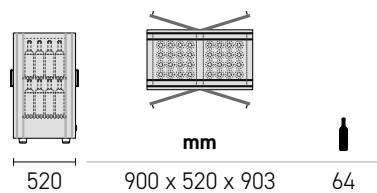

Allestimento interno personalizzabile
Custom internal layout



°C
+4 / +18

MD-H24



MD-M24

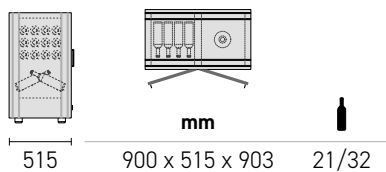

MD-C24

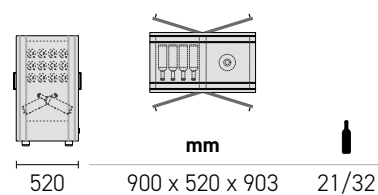



MD-H2-30

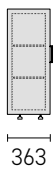

363



mm

900 x 363 x 903



MD-M2-30

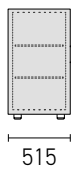

515

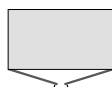

mm

900 x 515 x 903



MD-C2-30

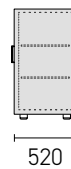

520

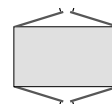

mm

900 x 520 x 903



MD-H2-31

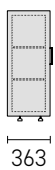

363



mm

486 x 363 x 903



MD-M2-31



515



mm

486 x 515 x 903



MD-C2-31

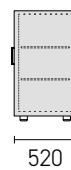

520



mm

486 x 520 x 903





MD-H2-01

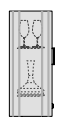

363

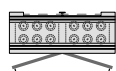

mm

900 x 363 x 903



MD-M2-01



515

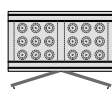

mm

900 x 515 x 903



MD-C2-01



520

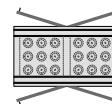

mm

900 x 520 x 903



MD-H2-02

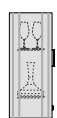

363



mm

486 x 363 x 903



MD-M2-02



515



mm

486 x 515 x 903



MD-C2-02



520



mm

486 x 520 x 903





Mod 20



Finiture Mod 20



RIVESTIMENTO FIT

Fit cladding

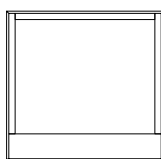

FN-RF*1D

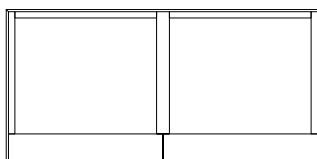

FN-RF*2D

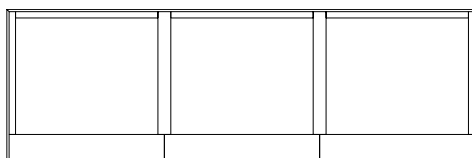

FN-RF*3D

COLORS

L01 - L10 - L11 - L20 - L21 - L22 - L23 - L30 - L40 - L42 - L50 - L51 - L52 - L53 - LM01 - LM02 - RAL

Il rivestimento lineare è realizzato in HPL e comprende il top, i fianchi laterali e lo sportello inferiore.

The linear cladding is made in HPL and includes top, side panes and lower front flap.



Arka





Arka

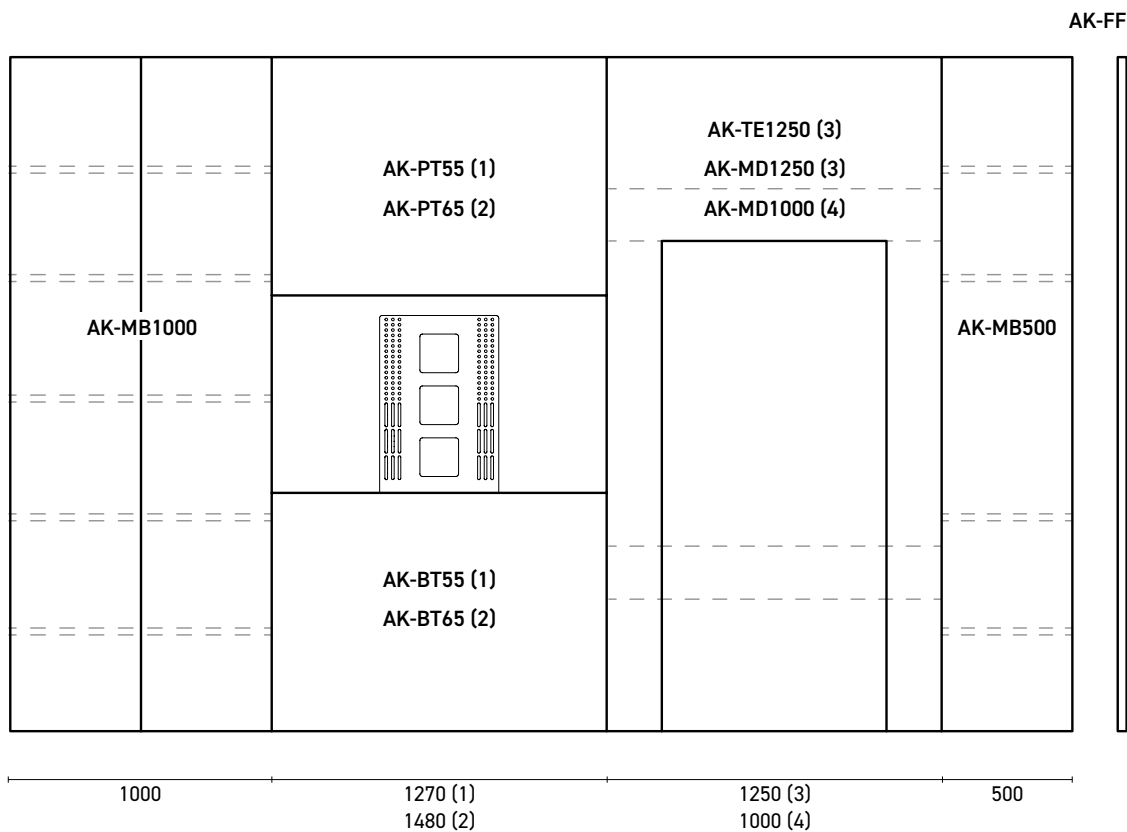

COLORS

ANTE
Doors

RAL 9010 - RAL 9005 - RAL

STRUTTURA INTERNA
Internal structure

N10



AK-MB500

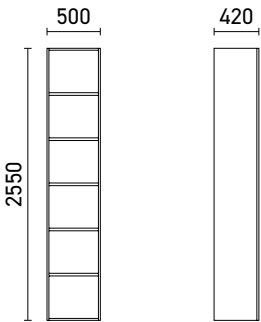
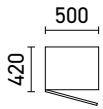

AK-MB1000

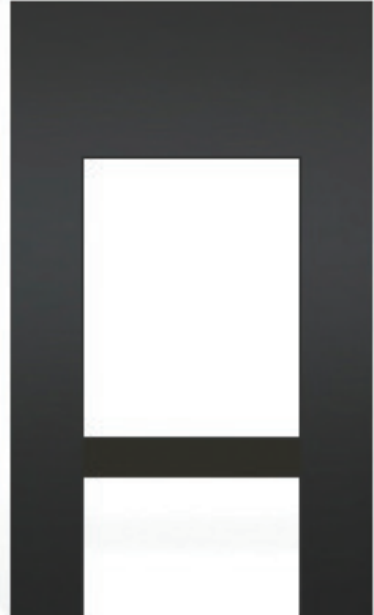
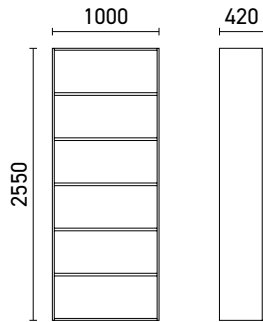
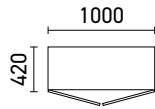

AK-TE1250

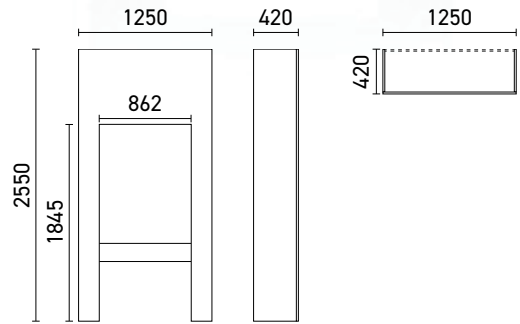

AK-MD1250

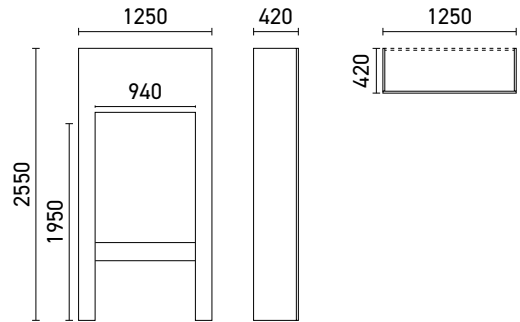

AK-MD1000

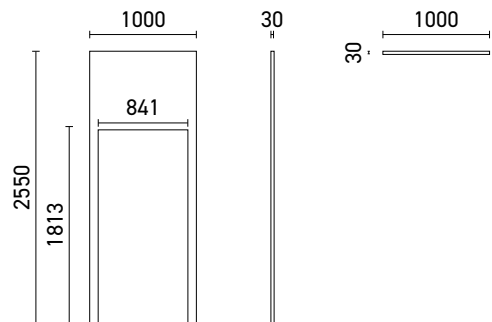



AK-FF

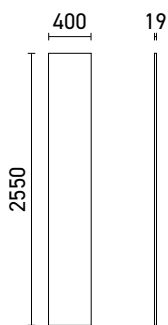

AK-BT55

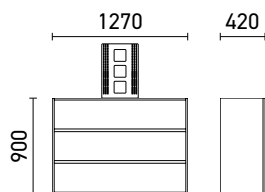
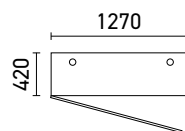

AK-PT55

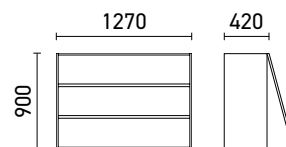
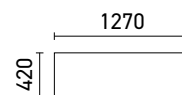

AK-BT65

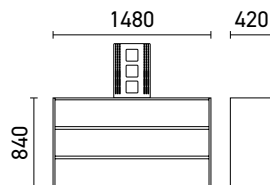
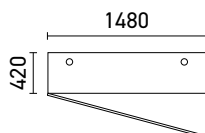

AK-PT65

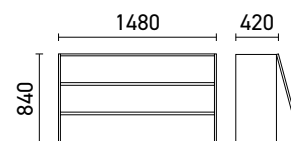
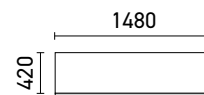

La staffa TV (idonea per TV 55" e 65")
viene fornita insieme alla base.

*The TV bracket (suitable for 55" and 65"
screen) is supplied with the base.*

AREA TECNICA

TECHNICAL AREA

Quadro Vino

CARATTERISTICHE TECNICHE

Specifications

Struttura in metallo
Struttura porta in alluminio
Cornice in legno / hpl / MDF
Vetrocamera 20 mm / Guarnizione magnetica
Pannello interno in acciaio
Illuminazione a LED bianco naturale
(4000 K - 60 led/mt - 4,8 W / mt - 416 lumen / mt dimmerabile - 12 V)
Sbrinamento automatico
Refrigerazione ventilata
Sistema di antivibrazione

*Metal structure
Aluminum door structure
Wood / HPL / MDF door frame
20 mm double glazing / Magnetic gasket
Internal steel panel
White natural daylight LED
(4000 K - 60 led/mt - 4,8 W / mt - 416 lumen / mt dimmer - 12 V)
Automatic defrosting
Ventilated refrigeration
Anti-vibration system*

CONFIGURATORE ONLINE

Online builder



THERMOELECTRIC COOLING SYSTEM

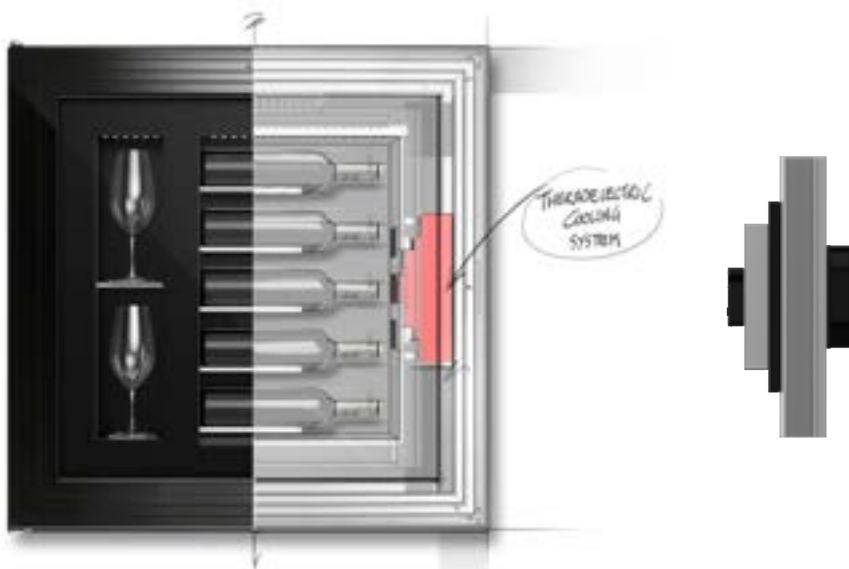

Disegnato ed ingegnerizzato per la specifica applicazione sul Quadro Vino, è pura tecnologia del freddo in miniatura. Il sistema utilizzato è termoelettrico. L'impianto è ecologico, privo di gas inquinanti e costruito con materiali completamente riciclabili.

Designed and engineered specifically for application on Quadro Vino, it is concentrated miniature cold technology. It employs a thermoelectrical system. It is a green system, free of polluting gases and built with entirely recyclable materials.



MODELLO • Model

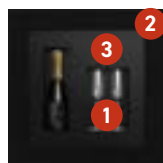

QV12

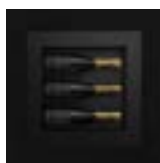

QV30

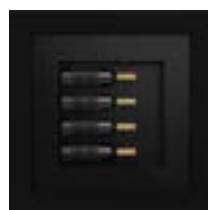

QV40

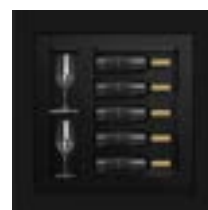

QV52

1 - STRUTTURA • Structure



Standard
RAL 9005
nero
black

N



Optional
RAL 9010
bianco
white

B

2 - CORNICI • Frames

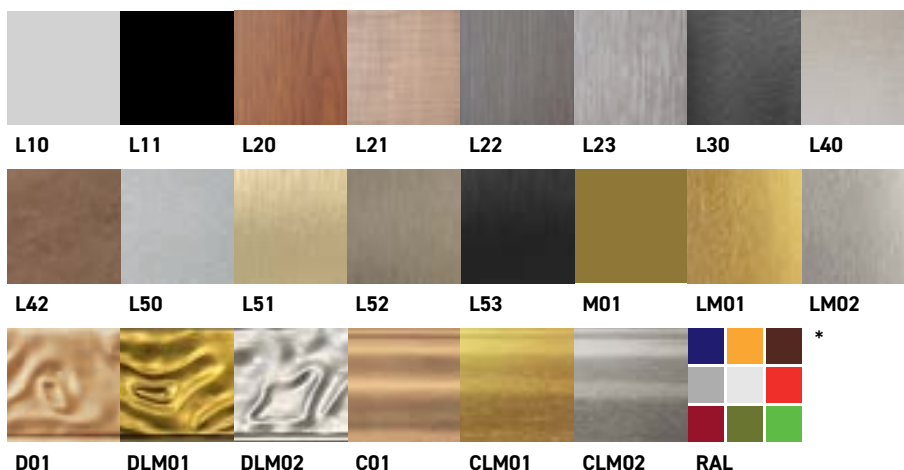

3 - PANNELLI • Panels













COLORE LUCE • Light colour

○○○ Standard: LED bianco naturale • white natural daylight LED





●●● Optional: LED blu • blue LED (OPT-QLB)

* I colori RAL vengono realizzati su supporto di MDF in finitura opaca 20 gloss. - * RAL colours are made on MDF 20-gloss matte finish.



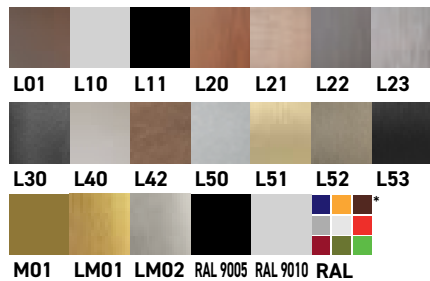



Quadro Vino

CODE	 mm LxPxH	 mm LxPxH	 mm LxPxH	N.  0,75 LT	 H Ø	 LT	Class
 QV12N	600 x 600 x 155	700 x 700 x 250	800 x 1000 x 390	1	H 324 Ø 105	3	SN-N
 QV30N	600 x 600 x 155	700 x 700 x 250	800 x 1000 x 390	3	H 328 Ø 98	11	SN-N
 QV40N	780 x 780 x 155	860 x 860 x 250	1000 x 1000 x 390	4	H 400 Ø 90	16	SN-N
 QV52N	780 x 780 x 155	860 x 860 x 250	1000 x 1000 x 390	5	H 328 Ø 90	15	SN-N

CORNICE • FRAMES















CODE	 L01 L10 L11 L20 L21 L22 L23 L30 L40 L42 L50 L51 L52 L53 M01 LM01 LM02 RAL 9005 RAL 9010 RAL	 Dune D01 DLM01 DLM02 DRAL 9005 DRAL 9010 DRAL	 Classica C01 CLM01 CLM02 CRAL
 QV1230C-	•	•	•
QV4052C-	•	•	•





PANNELLO • PANELS





CODE	 RAL 9010 RAL 9005	 E10 E11 E12 E13 E30 E31 E39 E40 E41 E50
 QV12P-	•	•
 QV30P-	•	•
 QV40P-	•	•
 QV52P-	•	•

* I colori RAL vengono realizzati su supporto di MDF in finitura opaca 20 gloss.

* RAL colours are made in MDF 20-gloss matte finish.

	 Energ	 P _{nom} W	 KWh annuum	 LIGHT	 dB	 V	 Kg	 Kg	 Kg	 m ³	 m ³	 °C TA 22 °C	 °C TA 25 °C	 °C TA 28 °C
G	30	238	NW	29	100 - 240V	22	25	33	0,1	0,3	+4 / +6	+6 / +8	+8 / +10	
G	60	194	NW	29	100 - 240V	22	25	33	0,1	0,3	+8 / +10	+10 / +12	+12 / +14	
G	60	182	NW	29	100 - 240V	30	39	45	0,2	0,4	+12 / +14	+14 / +16	+16 / +18	
G	60	198	NW	29	100 - 240V	30	39	45	0,2	0,4	+12 / +14	+14 / +16	+16 / +18	

 mm L x P x H	 Kg	 Kg	 m ³
600 x 600 x 10	2	18	0,02
780 x 780 x 10	2,5	20	0,02

 mm L x P x H	 Kg	 Kg	 m ³
540 x 540 x 1,2	-	-	-
540 x 540 x 1,2	-	-	-
715 x 715 x 1,2	-	-	-
715 x 715 x 1,2	-	-	-

Le temperature riportate sono indicative e possono variare di (+ -) 2 °C. Rilevazioni effettuate con temperatura ambiente di 25 °C.
 Reported temperatures are approximate and may vary by (+ -) 2 °C. Detections made in 25 °C ambient temperature.

Emme 12

CARATTERISTICHE TECNICHE

Specifications

Struttura in metallo
Struttura porta in alluminio
Cornice in legno / hpl / MDF
Vetrocamera 20 mm / Guarnizione magnetica
Pannello interno in acciaio
Illuminazione a LED bianco caldo
(3000 K - 160 led/mt - 14,4 W / mt - 1585 lumen / mt - 24 v)
Refrigerazione statica e ventilata
Termoregolatore digitale
Sbrinamento automatico
Sistema antivibrazione
Filtro a carboni attivi ricaricabile
Compressore ad inverter
Gestione tramite app Expo Connex

*Metal structure
Aluminum door structure
Wood / HPL / MDF door frame
20 mm double glazing / Magnetic gasket
Internal steel panel
Cold white daylight LED
(3000 K - 160 led/mt - 14,4 W / mt - 1585 lumen / mt - 24 v)
Static and ventilated refrigeration
Digital temperature controller
Automatic defrosting
Anti-vibration system
Rechargeable active carbon filter
Inverter compressor
Manage with Expo Connex app*

I modelli E-M12 e E-M12G devono essere fissati alla parete utilizzando le staffe in dotazione.

The E-M12, E-M12G models must be fixed to the wall with the provided brackets.

EXPO CONNEX

di serie • *standard*

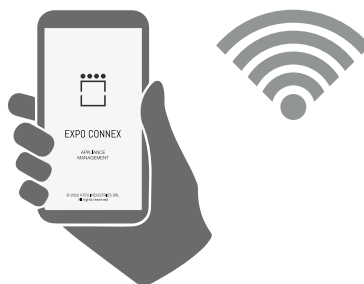

Expo ConneX è un'applicazione per il monitoraggio ed il controllo wireless dei prodotti Della Marta.

L'app permette all'utente di usufruire dei servizi di report settimanale e di alert tramite messaggi push e via mail. È possibile controllare e modificare, anche a distanza ed in tempo reale, le temperature e le impostazioni delle vetrine. Grazie a questo sistema di connessione sempre attivo, la vetrina viene monitorata e consente di ricevere supporto tecnico, tramite diagnostica, in qualsiasi parte del mondo il prodotto si trovi.

L'applicazione Expo Connex è disponibile su Play Store e App Store.

Expo ConneX is an app for wireless remote monitoring and control of Della Marta products.

This app allows the user to view weekly reports and receive push and email alerts. It allows to control and edit, remotely and in real time, temperature and settings of the cabinets. Thanks to this always-running connection system, the cabinet is monitored and remote technical support – through diagnostics – can be provided anywhere in the world.

Expo ConneX is available on the App Store and Play Store.



OPTIONAL DISPONIBILI SU TUTTI I MODELLI

Options available on all models

(Pag. 116)

OPT-RGB-CX · OPT-CBD-CX



EM-12



EM-12G

1 - CORNICI • *Frames*

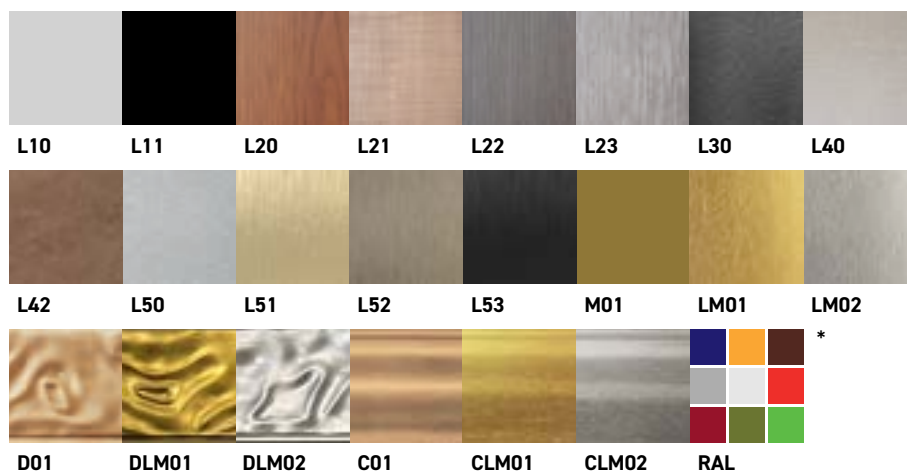











2 - PANNELLI • *Panels*



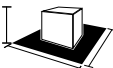

* I colori RAL vengono realizzati su supporto di MDF in finitura opaca 20 gloss. - * RAL colours are made on MDF 20-gloss matte finish.





Emme 12

CODE	 mm LxPxH	 N. 0,75 LT		Class	 Pnom	 KWh annum	 HF
	 mm LxPxH	 H Ø					 gr HF



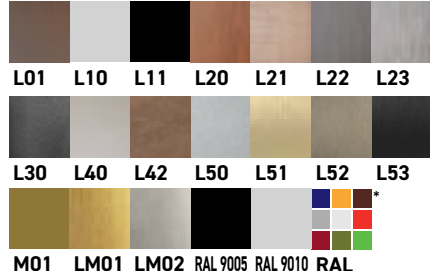

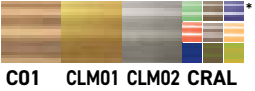
STRUTTURA • STRUCTURE

	EM-12	650 x 273 x 1696	12	60	SN-N	44 W	-	R 600 a
		1000 x 800 x 1900	H 324 Ø 105		230 50-60Hz			40
	EM-12G	650 x 273 x 1696	8	40	SN-N	44 W	-	R 600 a
		1000 x 800 x 1900	H 324 Ø 105		230 50-60Hz			40

CORNICE • FRAMES







CODE				
				
	E-M12-C	•	•	•











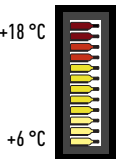

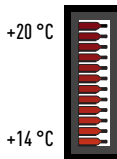
PANNELLO • PANELS

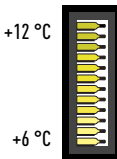

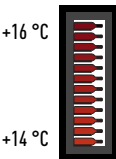

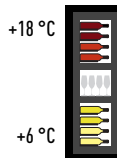
CODE			
		E-M12-P	•
	E-M12G-P	•	•

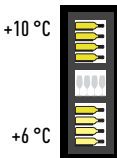



* I colori RAL vengono realizzati su supporto di MDF in finitura opaca 20 gloss.

* RAL colours are made in MDF 20-gloss matte finish.

		 		 OFF	 ON
--	---	--	---	--	---

NW	35	86	1,5	 +18 °C +6 °C SET 6 °C  25°C	 +20 °C +14 °C SET 14 °C  30°C	 +12 °C +6 °C SET 6 °C  25°C	 +16 °C +14 °C SET 14 °C  30°C
		111		 +18 °C +6 °C SET 6 °C  25°C	 +10 °C +6 °C SET 6 °C  25°C		

			
650 x 10 x 1668	3	40	0,35

			
600 x 1580 x 2	-	-	-
600 x 1580 x 2	-	-	-

Le temperature riportate sono indicative e possono variare di (+ -) 2 °C. Rilevazioni effettuate con temperatura ambiente di 25 °C.
 Reported temperatures are approximate and may vary by (+ -) 2 °C. Detections made in 25 °C ambient temperature.

Teca

La Teca ha una struttura in alluminio rivestita da una cornice in legno realizzabile con finiture e colori diversi. Questa scelta costruttiva permette di sostituire con semplicità sia le parti in vetro che la cornice in legno.

La Teca è disponibile nella versione a profondità ridotta (H) con condensatore statico installato nella parte posteriore e nella versione standard (M / C) dove è installato l'innovativo sistema di refrigerazione centrale basato sul posizionamento della serpentina di raffreddamento al centro della vetrina. Questo sistema consente la costruzione della vetrina centrale (C) con porte scorrevoli su entrambi i lati.

Teca features a wooden-clad aluminum structure that comes in different colors and finishes. This design choice allows for easy replacement both of glass parts and the wood frame.

Teca is available with reduced depth (H) with static condenser installed in the back, and standard depth (M / C) equipped with the innovative central refrigeration system with the cooling coil in the middle of the cabinet. This system makes it possible to have a central (C) system with sliding doors on both sides.

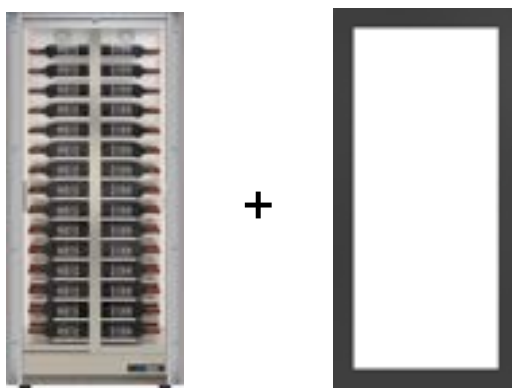

La Teca è composta da due elementi distinti che sono codificati e quotati separatamente:

- Vetrina con struttura in alluminio
- Cornice di finitura in legno/MDF

La cornice frontale viene applicata con bottoni a pressione pertanto la sostituzione è semplice ed immediata.

Teca is made of two separate elements and references:

- Unit with aluminium structure
- MDF/wood decorative frame.

The frame is mounted with a snap-on button system and therefore easy to replace.

I modelli TE-H10 e TE-H14 devono essere fissati alla parete utilizzando le staffe in dotazione.

The TE-H10, TE-H14 models must be fixed to the wall with the provided brackets.

OPTIONAL DISPONIBILI SU TUTTI I MODELLI

Options available on all models

(Pag. 116)

OPT-RGB · OPT-CBD · OPT-TCR · OPT-RGB-CX · OPT-CBD-CX · OPT-ABK



CARATTERISTICHE TECNICHE

Specifications

Struttura in alluminio
Cornice in MDF
Porte scorrevoli, fianchi e top con vetrocamera - protezione UV
Serratura con chiave
Interni in alluminio
Illuminazione a LED bianco caldo
(3000 K - 60 led/mt - 1,2 W / mt - 130 lumen / mt - 12V)
Refrigerazione statica e ventilata
Termoregolatore digitale
Sbrinamento automatico
Sistema antivibrazione
Filtro a carboni attivi ricaricabile
Compressore ad inverter

*Aluminium structure
MDF frame
Sliding doors, sides and top in double glass - anti-UV protection
Lock with key
Aluminium interior
Warm white LED
(3000 K - 60 led/mt - 1,2 W / mt - 130 lumen / mt - 12V)
Static and ventilated refrigeration
Digital temperature controller
Automatic defrosting
Anti-vibration system
Rechargeable active carbon filter
Inverter compressor*

CONFIGURATORE ONLINE

Online builder







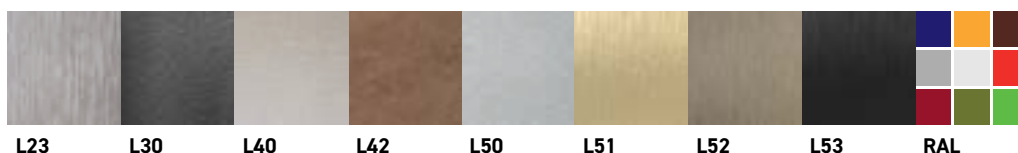
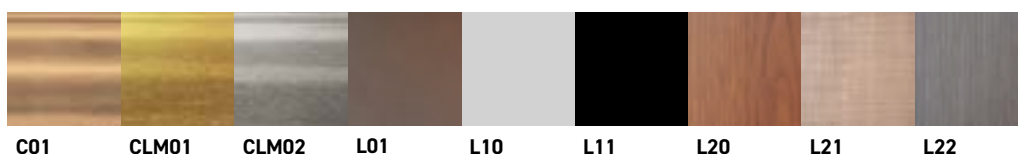

Nell'area "Configuratori" del sito www.dellamarta.it è disponibile uno strumento di visualizzazione che permette di vedere la Teca Vino da ogni prospettiva e scegliere tipologia e colore della Cornice.

The "Configurator" section of the website www.dellamarta.it features a viewing tool that lets you see the Teca Vino from every perspective and choose the type and finish among the available frames.

COLORS







Teca

CODE	mm LxPxH		N. 0,75 LT	H Ø	Class LT	P _{nom} W	INV	HF	LIGHT	dB
	mm LxPxH	mm LxPxH						HF		
 TE-H10	874 x 388 x 1865		60					R 600 a		
	1000 x 800 x 2060		H 320 Ø 93	293	3	120	INV	52	WW	37
 TE-M10	874 x 568 x 1865		120					R 600 a		
	1000 x 800 x 2060		H 320 Ø 90	540	3	120	INV	85	WW	39
 TE-C10	874 x 568 x 1865		120					R 600 a		
	1000 x 800 x 2060		H 320 Ø 90	570	3	120	INV	85	WW	39
 TE-M12	874 x 568 x 1865		112					R 600 a		
	1000 x 800 x 2060		H 350 Ø 95	540	3	120	INV	85	WW	39
 TE-C12	874 x 568 x 1865		112					R 600 a		
	1000 x 800 x 2060		H 350 Ø 95	570	3	120	INV	85	WW	39
 TE-M13	874 x 568 x 1865		128					R 600 a		
	1000 x 800 x 2060		-	540	3	120	INV	85	WW	39
 TE-C13	874 x 568 x 1865		128					R 600 a		
	1000 x 800 x 2060		-	570	3	120	INV	85	WW	39

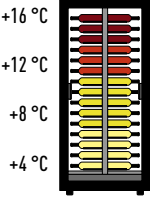
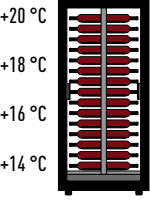
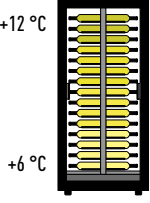
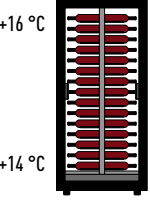
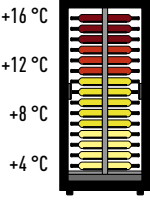
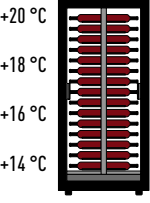
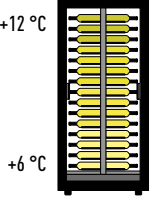
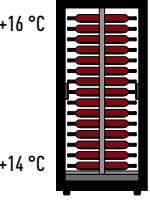
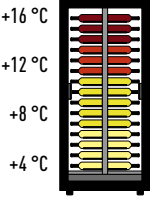
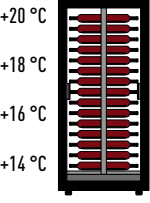
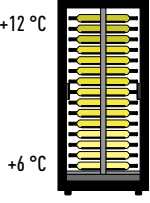
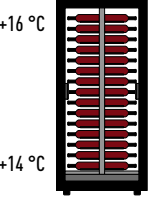
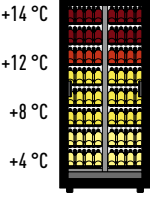
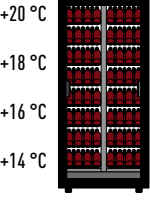
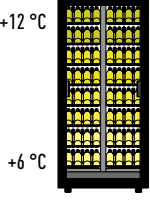
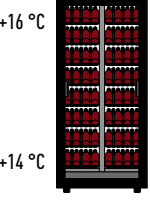
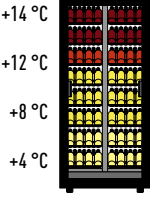
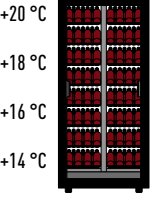
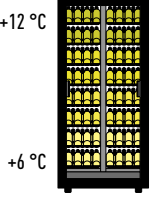
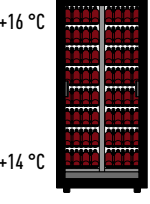
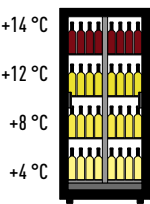
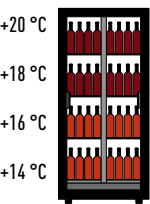
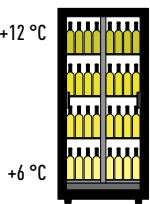
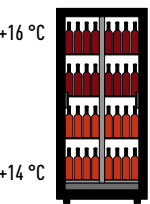
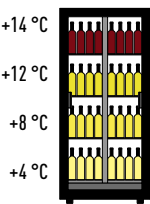
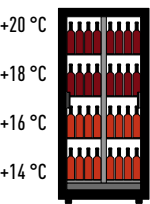
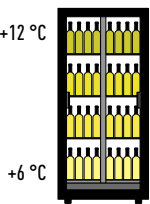
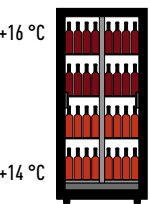

Le dimensioni indicate comprendono la cornice lineare

Reported dimensions include linear frame

 		 OFF	 ON
110	1,7	 +16 °C +12 °C +8 °C +4 °C SET 4 °C  +20 °C +18 °C +16 °C +14 °C SET 14 °C	 +12 °C +6 °C SET 6 °C  +16 °C +14 °C SET 14 °C
148			
138	1,7	 +16 °C +12 °C +8 °C +4 °C SET 4 °C  +20 °C +18 °C +16 °C +14 °C SET 14 °C	 +12 °C +6 °C SET 6 °C  +16 °C +14 °C SET 14 °C
170			
155	1,7	 +16 °C +12 °C +8 °C +4 °C SET 4 °C  +20 °C +18 °C +16 °C +14 °C SET 14 °C	 +12 °C +6 °C SET 6 °C  +16 °C +14 °C SET 14 °C
187			
138	1,7	 +14 °C +12 °C +8 °C +4 °C SET 4 °C  +20 °C +18 °C +16 °C +14 °C SET 14 °C	 +12 °C +6 °C SET 6 °C  +16 °C +14 °C SET 14 °C
170			
155	1,7	 +14 °C +12 °C +8 °C +4 °C SET 4 °C  +20 °C +18 °C +16 °C +14 °C SET 14 °C	 +12 °C +6 °C SET 6 °C  +16 °C +14 °C SET 14 °C
187			
138	1,7	 +14 °C +12 °C +8 °C +4 °C SET 4 °C  +20 °C +18 °C +16 °C +14 °C SET 14 °C	 +12 °C +6 °C SET 6 °C  +16 °C +14 °C SET 14 °C
170			
155	1,7	 +14 °C +12 °C +8 °C +4 °C SET 4 °C  +20 °C +18 °C +16 °C +14 °C SET 14 °C	 +12 °C +6 °C SET 6 °C  +16 °C +14 °C SET 14 °C
187			

Le temperature riportate sono indicative e possono variare di (+ -) 2 °C. Rilevazioni effettuate con temperatura ambiente di 25 °C.
 Reported temperatures are approximate and may vary by (+ -) 2 °C. Detections made in 25 °C ambient temperature.

Teca





CODE	mm LxPxH		N. 0,75 LT	H Ø	Class ⚡	Pnom W	INV	HF	LIGHT	dB
	mm LxPxH							HF		
 TE-H14 ^S	874 x 388 x 1865		OPT14	293	3	120	INV	R 600 a	WW	37
	1000 x 800 x 2060							230 50-60Hz		
 TE-M14 ^S	874 x 568 x 1865		OPT14	540	3	120	INV	R 600 a	WW	39
	1000 x 800 x 2060							230 50-60Hz		
 TE-C14 ^S	874 x 568 x 1865		OPT14	570	3	120	INV	R 600 a	WW	39
	1000 x 800 x 2060							230 50-60Hz		

Le dimensioni indicate comprendono la cornice lineare · Reported dimensions include linear frame

S. Senza allestimento interno · Without inside fittings



OPT14 - Pag. 118 

CORNICI



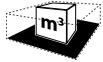

CODE	 M01 LM01 LM02 RAL 9005 RAL 9010 RAL					Dune  D01 DLM01 DLM02			Classica  C01 CLM01 CLM02 CRAL			
	 DRAL 9005 DRAL 9010 DRAL											
 T1-H*	•					•			•			
T1-M*	•					•			•			
T1-C*	•					•			•			

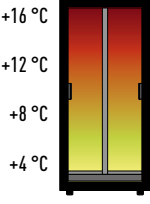
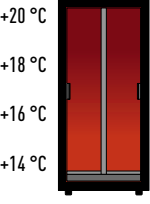
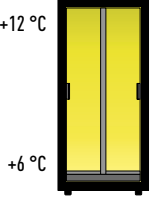
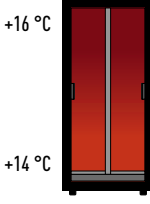
* I colori RAL vengono realizzati su supporto di MDF in finitura opaca 20 gloss.

* RAL colours are made on MDF 20-gloss matte finish.

 		 OFF	 ON
110	1,7	 +16 °C +12 °C +8 °C +4 °C SET 4 °C  +20 °C +18 °C +16 °C +14 °C SET 14 °C	 +12 °C +6 °C SET 6 °C  +16 °C +14 °C SET 14 °C
148			
138	1,7		
170			
155	1,7		
187			

Le temperature riportate sono indicative e possono variare di (+ -) 2 °C. Rilevazioni effettuate con temperatura ambiente di 25 °C.
 Reported temperatures are approximate and may vary by (+ -) 2 °C. Detections made in 25 °C ambient temperature.

			
874 x 1828 x 10	6	70	0,45
874 x 1828 x 10	6	70	0,45
874 x 1828 x 10	12	70	0,45

Teca B

Versione ad incasso della vetrina Teca.

La Teca B è semplice da installare in nicchie o passaggi inutilizzati.

La cornice è applicata con sistema ad incastro per cui facilmente sostituibile per qualsiasi esigenza tecnica o commerciale.

La versione a profondità ridotta (H) può essere inserita nei soggiorni Arka.

Built-in version of the Teca cabinet.

Teca B is easy to install in recesses or unused spaces.

The frame is mounted with a snap-on system and therefore easily replaced for any technical or sales need.

The reduced depth version (H) may be included in Arka furniture.



La Teca B è composta da due elementi distinti che sono codificati e quotati separatamente:

- Vetrina con struttura in alluminio
- Cornice di finitura in MDF/HPL

La cornice frontale viene applicata con bottoni a pressione pertanto la sostituzione è semplice ed immediata.

Teca B is made of two separate elements and references:

- *Unit with aluminium structure*
- *MDF/HPL decorative frame.*

The frame is mounted with a snap-on button system and therefore easy to replace.

I modelli TE-BH10 e TE-BH14 devono essere fissati alla parete utilizzando le staffe in dotazione.

The TE-BH10, TE-BH14 models must be fixed to the wall with the provided brackets.

OPTIONAL DISPONIBILI SU TUTTI I MODELLI

Options available on all models

(Pag. 116)

OPT-RGB · OPT-CBD · OPT-TCR · OPT-RGB-CX · OPT-CBD-CX · OPT-ABK

COLORS





CARATTERISTICHE COSTRUTTIVE

Features

Struttura in alluminio
 Cornice in HPL / MDF
 Porte scorrevoli con vetrocamera - protezione UV
 Serratura con chiave
 Fianchi e top in pannelli di schiuma poliuretanic
 Interni in alluminio
 Illuminazione a LED bianco caldo
 (3000 K - 60 led/mt - 1,2 W / mt - 130 lumen / mt - 12V)
 Compressore ad inverter
 Refrigerazione statica e ventilata
 Termoregolatore digitale
 Sbrinamento automatico
 Sistema antivibrazione
 Filtro a carboni attivi ricaricabile

Aluminium structure
 HPL / MDF frame
 Sliding doors in double glass - anti-UV protection
 Lock with key
 Sides and top panels polyurethane foam
 Aluminium interior
 Warm white LED
 (3000 K - 60 led/mt - 1,2 W / mt - 130 lumen / mt - 12V)
 Inverter compressor
 Static and ventilated refrigeration
 Digital temperature controller
 Automatic defrosting
 Anti-vibration system
 Rechargeable active carbon filter

MISURE PER INCASSO A PARETE

Built-in installation dimensions

Dimensioni nicchia per incasso a parete (TB-H*)
 Recess measures for building-in (TB-H*)

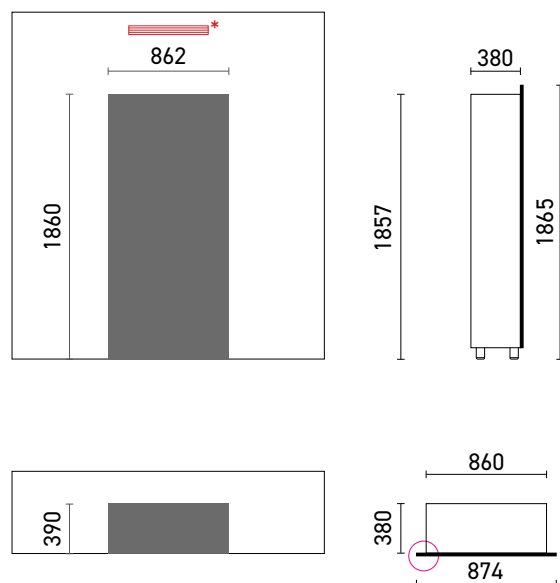

Dimensioni nicchia per incasso a parete (TB-M*)
 Recess measures for building-in (TB-M*)

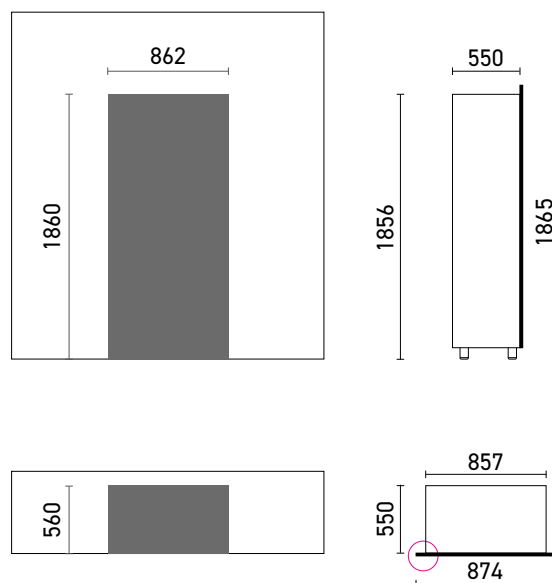

	HPL	7 mm
	MDF	10 mm
	DUNE	17 mm
	CLASSICA	27 mm

I modelli TB-H* devono essere fissati alla parete utilizzando le staffe in dotazione.

The TB-H* models must be fixed to the wall with the provided brackets.











* Prevedere nella parte alta della parete dove viene incassata la vetrina un'apertura di circa 160 cm² (ad esempio cm 80x2) che consenta la fuoriuscita dell'aria calda (solo TB*-H).

* Include an opening of about 160 cm² (for example, cm 80x2) above the niche in which the showcase is built in to allow the discharge of warm air (only TB*-H).

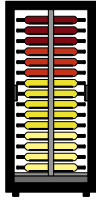
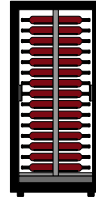
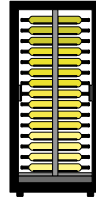
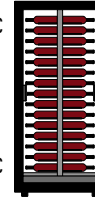
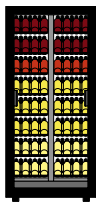
Teca B Built-in/Incasso

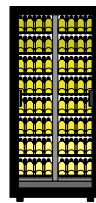
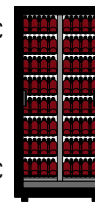

CODE	mm LxPxH		N. 0,75 LT	H Ø	Class LT	P _{nom} W	INV	HF	LIGHT	dB
	mm LxPxH							HF		
 TE-BH10	874 x 388 x 1865		60		3			R 600 a	WW	37
	1000 x 800 x 2060		H 320 Ø 93	293	230 50-60Hz	120	INV	52		
 TE-BM10	874 x 557 x 1865		120		3			R 600 a	WW	39
	1000 x 800 x 2060		H 320 Ø 90	540	230 50-60Hz	120	INV	85		
 TE-BC10	874 x 568 x 1865		120		3			R 600 a	WW	39
	1000 x 800 x 2060		H 320 Ø 90	540	230 50-60Hz	120	INV	85		
 TE-BM12	874 x 557 x 1865		112		3			R 600 a	WW	39
	1000 x 800 x 2060		H 350 Ø 95	540	230 50-60Hz	120	INV	85		
 TE-BC12	874 x 568 x 1865		112		3			R 600 a	WW	39
	1000 x 800 x 2060		H 350 Ø 95	540	230 50-60Hz	120	FIX	85		
 TE-BM13	874 x 557 x 1865		128		3			R 600 a	WW	39
	1000 x 800 x 2060		-	540	230 50-60Hz	120	INV	85		
 TE-BC13	874 x 568 x 1865		128		3			R 600 a	WW	39
	1000 x 800 x 2060		-	540	230 50-60Hz	120	INV	85		

Le dimensioni indicate comprendono la cornice lineare - Reported dimensions include linear frame

		 		 OFF	 ON
97	1,7				
135					
109	1,7	+16 °C +12 °C +8 °C +4 °C  SET 4 °C	+20 °C +18 °C +16 °C +14 °C  SET 14 °C	+12 °C +6 °C  SET 6 °C	+16 °C +14 °C  SET 14 °C
141					
109	1,7				
141					
109	1,7	+14 °C +12 °C +8 °C +4 °C  SET 4 °C	+20 °C +18 °C +16 °C +14 °C  SET 14 °C	+12 °C +6 °C  SET 6 °C	+16 °C +14 °C  SET 14 °C
141					
109	1,7				
141					
116	1,7				
122					
116	1,7	+14 °C +12 °C +8 °C +4 °C  SET 4 °C	+20 °C +18 °C +16 °C +14 °C  SET 14 °C	+12 °C +6 °C  SET 6 °C	+16 °C +14 °C  SET 14 °C
122					

Le temperature riportate sono indicative e possono variare di (+ -) 2 °C. Rilevazioni effettuate con temperatura ambiente di 25 °C.
 Reported temperatures are approximate and may vary by (+ -) 2 °C. Detections made in 25 °C ambient temperature.

Teca B Built-in/Incasso

CODE	mm LxPxH		N. 0,75 LT	H Ø	Class LT	P _{nom} W	INV	HF	LIGHT	dB
	mm LxPxH							HF		
 TE-BH14 ^S	874 x 388 x 1865		OPT14	293	3	120	INV	R 600 a	WW	37
	1000 x 800 x 2060							52		
 TE-BM14 ^S	874 x 557 x 1865		OPT14	540	3	120	INV	R 600 a	WW	39
	1000 x 800 x 2060							85		
 TE-BC14 ^S	874 x 568 x 1856		OPT14	540	3	120	INV	R 600 a	WW	39
	1000 x 800 x 2060							85		

S. Senza allestimento interno · Without inside fittings



OPT14 - Pag. 118





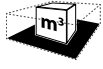

CORNICI

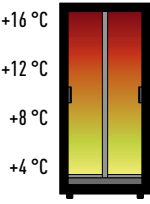
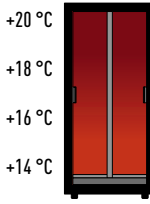
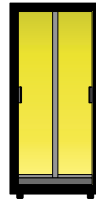
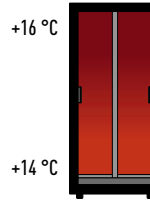
CODE	L							Dune			Classica			
	L01	L10	L11	L20	L21	L22	L23	D01	DLM01	DLM02	C01	CLM01	CLM02	CRAL
 TB1-	•							•			•			

* I colori RAL vengono realizzati su supporto di MDF in finitura opaca 20 gloss. - * RAL colours are made on MDF 20-gloss matte finish.

		OFF		ON	
					
					
97	1,7	 	 		
135					
97	1,7				
141					
97	1,7				
141					

			
874 x 1828 x 10	6	70	0,45

Mod 10

CARATTERISTICHE COSTRUTTIVE

Features

Struttura in alluminio
Porte a battente con vetrocamera - protezione UV
Serratura con chiave
Fianchi e top in pannelli di schiuma poliuretanaica
Interni in alluminio
Illuminazione a LED bianco caldo
(3000 K - 60 led/mt - 1,2 W / mt - 130 lumen / mt - 12V)
Compressore ad inverter
Refrigerazione statica e ventilata
Termoregolatore digitale
Sbrinamento automatico
Sistema di antivibrazione
Filtro a carboni attivi ricaricabile

*Aluminium structure
Hinged doors with double glazing – UV protection
Lock with key
Sides and top panels polyurethane foam
Aluminium interior
Warm white LED
(3000 K - 60 led/mt - 1,2 W / mt - 130 lumen / mt - 12V)
Inverter compressor
Static and ventilated refrigeration
Digital temperature controller
Automatic defrosting
Anti-vibration system
Rechargeable active carbon filter*

I modelli MD-H10 e MD-H14 devono essere fissati alla parete utilizzando le staffe in dotazione.

The MD-H10, MD-H14 models must be fixed to the wall with the provided brackets.

CONFIGURATORE ONLINE

Online builder



INSTALLAZIONE CON CORNICE

Frame installation



Appoggio

Nell'installazione ad appoggio possono essere inseriti uno o più dei seguenti modelli (con il lato posteriore chiuso): MD-H10 · MD-M10 · MD-M12 · MD-H14 · MD-M14. Occorre inoltre completare la composizione aggiungendo una cornice e due pannelli laterali oppure il rivestimento Fit.



Centrale

Nell'installazione centrale possono essere inseriti uno o più dei seguenti modelli (porte apribili su entrambi i lati): MD-C10 · MD-C12 · MD-C14. Occorre inoltre completare la composizione aggiungendo due cornici, una per ciascun lato, e due pannelli laterali oppure il rivestimento Fit.



Incasso

Nell'installazione ad incasso possono essere inseriti uno o più dei seguenti modelli (con il lato posteriore chiuso): MD-H10 · MD-M10 · MD-M12 · MD-H14 · MD-M14. Occorre inoltre completare la composizione aggiungendo una cornice. Non occorrono i pannelli laterali.

Standing

In a standing installation, one or more of the following modules can be included (closed back side): MD-H10 · MD-M10 · MD-M12 · MD-H14 · MD-M14. It is also necessary to complete the composition by adding one frame and two side panels or a Fit cladding.

Central

In a central installation one or more of the following modules can be included (doors on both sides): MD-C10 · MD-C12 · MD-C14. It is also necessary to complete the composition by adding two frames (one for each side) and two side panels or a Fit cladding.

Built-in

In a built-in installation, one or more of the following modules can be included (closed back side): MD-H10 · MD-M10 · MD-M12 · MD-H14 · MD-M14. It is also necessary to complete the composition by adding one frame. No side panels needed.

CORNICI

Frame



CORNICE LINEARE (CL)
PLAIN FRAME (CL)

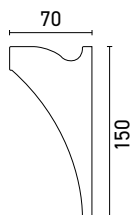

CORNICE SAGOMATA (CS)
MOULDED FRAME (CS)

PANNELLI LATERALI

Side panels

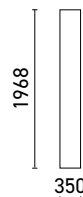

FN-PLHA

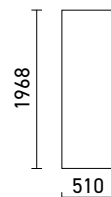

FN-PLA

Misure per incasso a parete

Size of built-in units

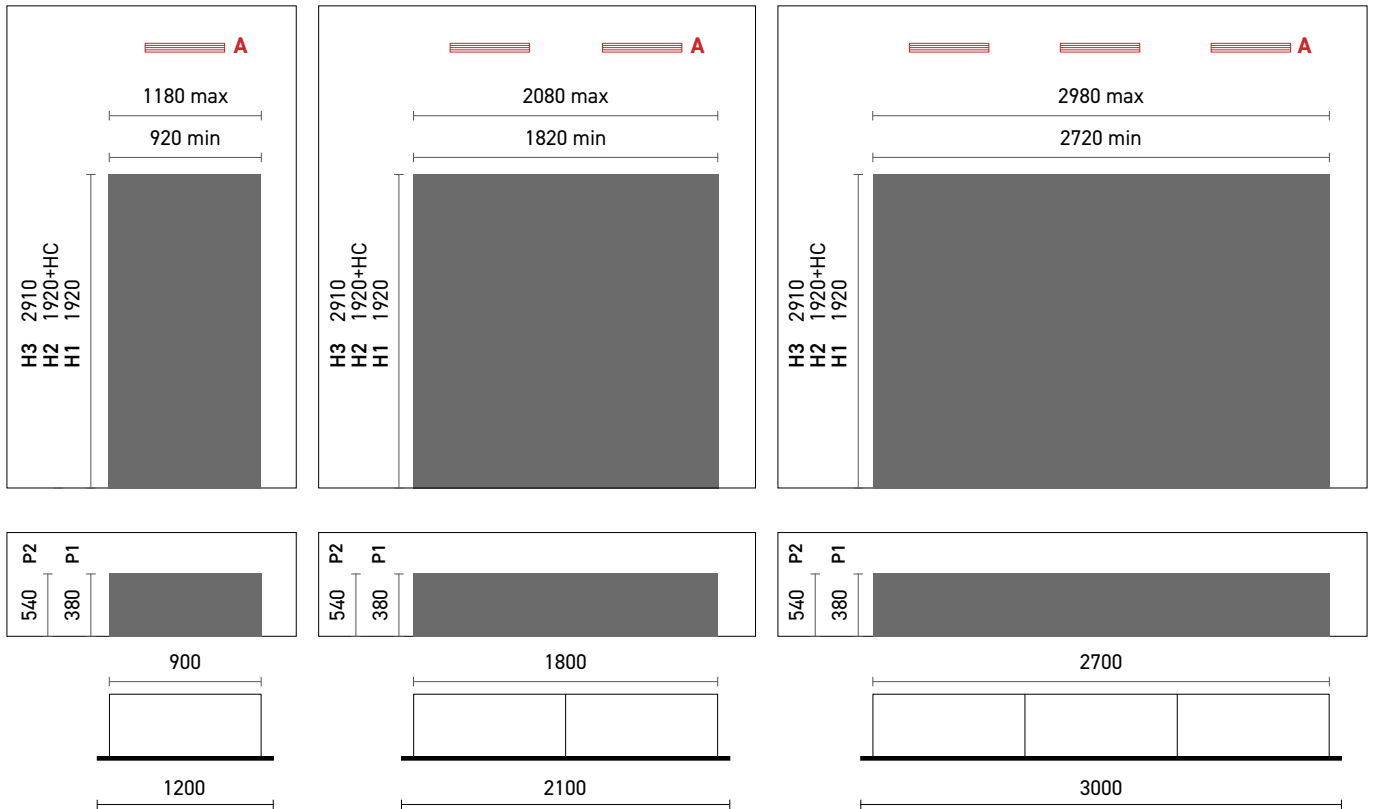

(P1) PH* • (P2) PM* • PC* • (H1) A • (H2) A + C • (H3) A + B

HC (altezze del cavalletto disponibili) • HC (available stand height): mm 150 - 200 - 250 - 300 - 350 - 400 - 450

A Prevedere nella parte alta della parete dove viene incassata la vetrina un'apertura di minimo 160 cm² che consenta la fuoriuscita dell'aria calda (solo PH).

A Include an opening of minimum 160 cm² above the niche where the cabinet is built in to allow discharge of warm air (PH only).

Rivestimento Fit

Fit cladding

Rivestimento completo top, fianchi e frontalino

Complete cladding for top, sides and front flap



(1) MD-H*
(2) MD-M* • MD-C*

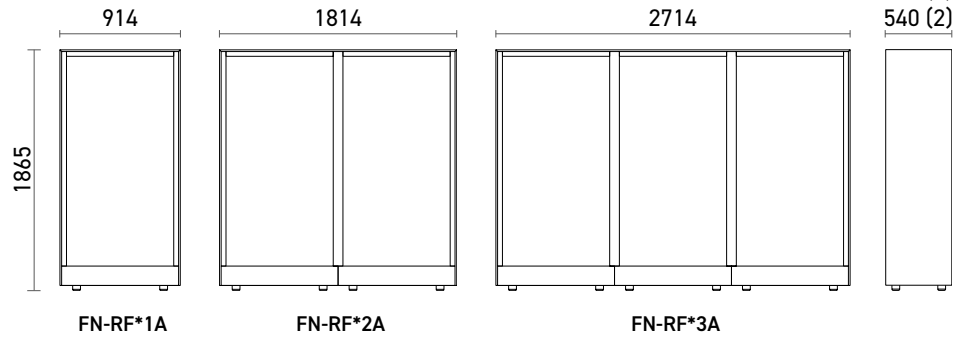



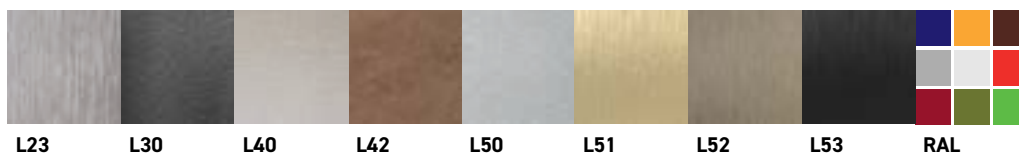
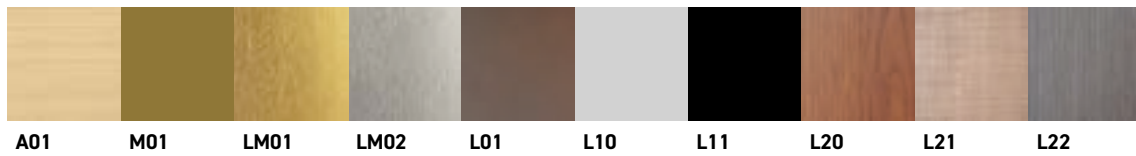

COLORS





Mod 10

CODE	mm LxPxH		N. 0,75 LT	H Ø	Class LT	P _{nom} W	INV	HF	LIGHT	dB
	mm LxPxH	mm LxPxH						HF		
 MD-H10	900 x 363 x 1858	■	60	278	3	120	INV	R 600 a	WW	37
	1000 x 800 x 2060		H 360 Ø 93		230 50-60Hz			52		
 MD-M10	900 x 515 x 1858	■	120	545	3	120	INV	R 600 a	WW	39
	1000 x 800 x 2060		H 360 Ø 90		230 50-60Hz			85		
 MD-C10	900 x 520 x 1858	□	120	557	3	120	INV	R 600 a	WW	39
	1000 x 800 x 2060		H 360 Ø 90		230 50-60Hz			85		
 MD-M12	900 x 515 x 1858	■	112	545	3	120	INV	R 600 a	WW	39
	1000 x 800 x 2060		H 350 Ø 95		230 50-60Hz			85		
 MD-C12	900 x 520 x 1858	□	112	557	3	120	INV	R 600 a	WW	39
	1000 x 800 x 2060		H 350 Ø 95		230 50-60Hz			85		
 MD-M13	900 x 515 x 1858	■	128	545	3	120	INV	R 600 a	WW	39
	1000 x 800 x 2060		-		230 50-60Hz			85		
 MD-C13	900 x 520 x 1858	□	128	557	3	120	INV	R 600 a	WW	39
	1000 x 800 x 2060		-		230 50-60Hz			85		

		OFF		ON	
 		 OFF		 ON	
97	1,7				
117					
107	1,7	+16 °C +12 °C +8 °C +4 °C SET 4 °C	+20 °C +18 °C +16 °C +14 °C SET 14 °C	+8 °C +4 °C SET 4 °C	+16 °C +14 °C SET 14 °C
132					
120	1,7				
145					
107	1,7	+14 °C +12 °C +8 °C +4 °C SET 4 °C	+20 °C +18 °C +16 °C +14 °C SET 14 °C	+8 °C +4 °C SET 4 °C	+16 °C +14 °C SET 14 °C
132					
141	1,7				
166					
117	1,7	+14 °C +12 °C +8 °C +4 °C SET 4 °C	+20 °C +18 °C +16 °C +14 °C SET 14 °C	+8 °C +4 °C SET 4 °C	+16 °C +14 °C SET 14 °C
142					
151	1,7				
176					

Le temperature riportate sono indicative e possono variare di (+ -) 2 °C. Rilevazioni effettuate con temperatura ambiente di 25 °C.
 Reported temperatures are approximate and may vary by (+ -) 2 °C. Detections made in 25 °C ambient temperature.

Mod 10







CODE	mm LxPxH		N. 0,75 LT	H Ø	Class LT	Pnom W	INV	HF	LIGHT	dB
	mm LxPxH	mm LxPxH								
 MD-H14 ^S	900 x 363 x 1858		OPT14	278	3	120	INV	R 600 a	WW	37
	1000 x 800 x 2060									
 MD-M14 ^S	900 x 515 x 1858		OPT14	545	3	120	INV	R 600 a	WW	39
	1000 x 800 x 2060									
 MD-C14 ^S	900 x 520 x 1858		OPT14	557	3	120	INV	R 600 a	WW	39
	1000 x 800 x 2060									

S. Senza allestimento interno · Without inside fittings





OPT14 - Pag. 118







MODULI NEUTRI · Neutral modules









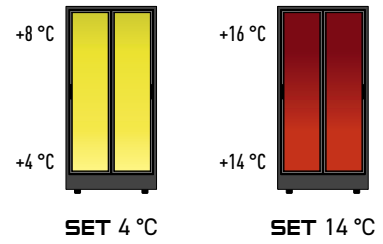
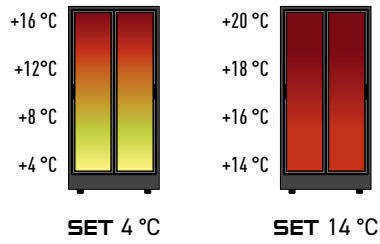



CODE	mm LxPxH	mm LxPxH	LT	Pnom W	KWh annum
 MD-H1-01	900 x 363 x 1858	1000 x 800 x 2060	278	4 W	35
 MD-M1-01	900 x 515 x 1858	1000 x 800 x 2060	545	8 W	70
 MD-C1-01	900 x 520 x 1858	1000 x 800 x 2060	577	8 W	70
 MD-H1-02	486 x 363 x 1858	600 x 800 x 2060	142	4 W	35
 MD-M1-02	486 x 515 x 1858	600 x 800 x 2060	285	8 W	70
 MD-C1-02	486 x 520 x 1858	600 x 800 x 2060	295	8 W	70

* I colori RAL vengono realizzati su supporto di MDF in finitura opaca 20 gloss. - * RAL colours are made in MDF 20-gloss matte finish.





				 OFF	 ON
97	1,7				
117					
103	1,7				
128					
116	1,7				
141					

				 OFF	 ON
97	1,7				
117					
103	1,7				
128					
116	1,7				
141					











						
	6	WW	100 - 240V	95	120	1,7
	6	WW	100 - 240V	105	130	1,7
	6	WW	100 - 240V	127	152	1,7
	3	WW	100 - 240V	45	58	0,9
	3	WW	100 - 240V	55	68	0,9
	3	WW	100 - 240V	72	85	0,9

Finiture Mod 10

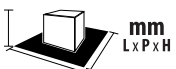
CODE	L01	A01	M01	L20 L21	L22 L23	L10 L11 L30 L40 L42	L50 L51 L52 L53 RAL	LM01 LM02
CORNICI • FRAMES								
	FN-CL1A	•	-	-	•	•		•
	FN-CL2A	•	-	-	•	•		•
	FN-CL3A	•	-	-	•	•		•
	FN-CS1A	-	•	-	-	-		•
	FN-CS2A	-	•	-	-	-		•
	FN-CS3A	-	•	-	-	-		•
PANNELLI LATERALI • SIDES PANELS								
	FN-PLHA	•	-	-	•	•		-
	FN-PLA	•	-	-	•	•		-
RIVESTIMENTO FIT • Fit cladding								
	FN-RFH1A	•	-	-	•	•		-
	FN-RFM1A	•	-	-	•	•		-
	FN-RFC1A	•	-	-	•	•		-
	FN-RFH2A	•	-	-	•	•		-
	FN-RFM2A	•	-	-	•	•		-
	FN-RFC2A	•	-	-	•	•		-
	FN-RFH3A	•	-	-	•	•		-
	FN-RFM3A	•	-	-	•	•		-
	FN-RFC3A	•	-	-	•	•		-

Con le finiture A01 e L01 le fascette magnetiche sono in metallo non verniciato.
With A01 and L01, magnetic strips are in unfinished metal.

* I colori RAL vengono realizzati su supporto di MDF o HPL in finitura opaca 20 gloss.
* RAL colours are made in MDF or HPL 20-gloss matte finish.

 mm LxPxH	 mm LxPxH	 mm LxPxH		 Kg	 Kg	 Kg	 m ³	 m ³
---	---	---	---	--	---	--	--	--

1968 x 1200 x 7	2250 x 600 x 100	2250 x 600 x 250	•	14	26	34	0,2	0,4
1968 x 2100 x 7	2250 x 600 x 100	2250 x 600 x 250	•	17	29	37	0,2	0,4
1968 x 3000 x 7	3120 x 600 x 100	3120 x 600 x 250	•	21	36	44	0,2	0,5
1968 x 1200 x 70	2250 x 600 x 150	2250 x 600 x 300	•	13	31	39	0,2	0,4
1968 x 2100 x 70	2250 x 600 x 150	2250 x 600 x 300	•	16	34	42	0,2	0,4
1968 x 3000 x 70	3120 x 600 x 150	3120 x 600 x 300	•	19	42	50	0,3	0,6

1968 x 350 x 5	-	-	-	-	-	-	-	-
1968 x 510 x 5	-	-	-	-	-	-	-	-

-	-	-	-	23	-	-	-	-
-	-	-	-	28	-	-	-	-
-	-	-	-	30	-	-	-	-
-	-	-	-	29	-	-	-	-
-	-	-	-	35	-	-	-	-
-	-	-	-	38	-	-	-	-
-	-	-	-	35	-	-	-	-
-	-	-	-	42	-	-	-	-
-	-	-	-	47	-	-	-	-

Mod 20

È un sistema componibile. La composizione può essere realizzata utilizzando sia le vetrine refrigerate che i mobili neutri. Il rivestimento esterno è in HPL con bordo lavorato a 45 gradi.

Modular system. Compositions can be made by using both refrigerated and non-refrigerated cabinets. External cladding is in HPL with 45-degree carved edge.

CARATTERISTICHE COSTRUTTIVE (Modelli refrigerati)

Features (refrigerated modules)

Struttura in alluminio
Porte a battente con vetrocamera - protezione UV
Serratura con chiave
Fianchi e top in pannelli di schiuma poliuretana
Interni in alluminio
Illuminazione a LED bianco caldo
(3000 K - 60 led/mt - 1,2 W / mt - 130 lumen / mt - 12V)
Compressore ad inverter
Refrigerazione statica e ventilata
Termoregolatore digitale
Sbrinamento automatico
Sistema antivibrazione
Filtro a carboni attivi ricaricabile

*Aluminium structure
Hinged doors with double glazing - UV protection
Lock with key
Sides and top panels polyurethane foam
Aluminium interior
Warm white LED
(3000 K - 60 led/mt - 1,2 W / mt - 130 lumen / mt - 12V)
Inverter compressor
Static and ventilated refrigeration
Digital temperature controller
Automatic defrosting
Anti-vibration system
Rechargeable active carbon filter*

CARATTERISTICHE COSTRUTTIVE (Modelli neutri)

Features (non-refrigerated modules)

Struttura in nobilitato
Ante in HPL
Piani regolabili
Chiusura delle ante rallentata

*Melamine structure
HPL doors
Adjustable shelves
Soft close doors*



OPTIONAL DISPONIBILI SU TUTTI I MODELLI

Options available on all models

(Pag. 116)

OPT-RGB · OPT-CBD · OPT-TCR · OPT-RGB-CX · OPT-CBD-CX · OPT-ABK

INSTALLAZIONE CON RIVESTIMENTO FIT



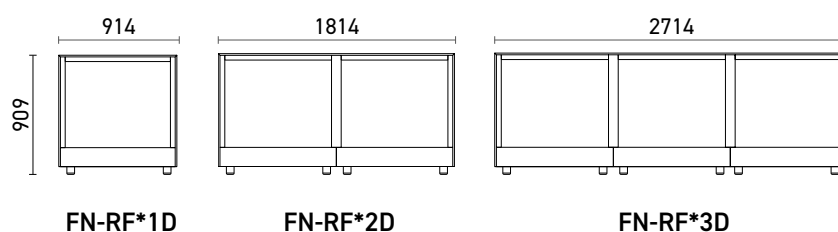



FIT cladding installation



Rivestimento completo top, fianchi e frontalino

Complete cladding for top, sides and front flap











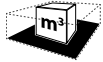







Mod 20

CODE	mm LxPxH		N. 0,75 LT	H Ø	Class LT	P _{nom} W	INV	HF	LIGHT	dB	
	mm LxPxH							9t HF			
 MD-H20	900 x 363 x 903	■	24	H 360 Ø 93	113	3	120	INV	R 600 a	WW	37
	1000 x 800 x 1120								230 50-60Hz		
 MD-M20	900 x 515 x 903	■	48	H 360 Ø 90	222	3	120	INV	R 600 a	WW	39
	1000 x 800 x 1120								230 50-60Hz		
 MD-C20	900 x 520 x 903	□	48	H 360 Ø 90	227	3	120	INV	R 600 a	WW	39
	1000 x 800 x 1120								230 50-60Hz		
 MD-M22	900 x 515 x 903	■	42	H 350 Ø 95	222	3	120	INV	R 600 a	WW	39
	1000 x 800 x 1120								230 50-60Hz		
 MD-C22	900 x 520 x 903	□	42	H 350 Ø 95	227	3	120	INV	R 600 a	WW	39
	1000 x 800 x 1120								230 50-60Hz		
 MD-M23	900 x 515 x 903	■	64	-	222	3	120	INV	R 600 a	WW	39
	1000 x 800 x 1120								230 50-60Hz		
 MD-C23	900 x 520 x 903	□	64	-	227	3	120	INV	R 600 a	WW	39
	1000 x 800 x 1120								230 50-60Hz		
 MD-H24 ^S	900 x 363 x 903	■	OPT14		113	3	120	INV	R 600 a	WW	37
	1000 x 800 x 1120								230 50-60Hz		
 MD-M24 ^S	900 x 515 x 903	■	OPT14		222	3	120	INV	R 600 a	WW	39
	1000 x 800 x 1120								230 50-60Hz		
 MD-C24 ^S	900 x 520 x 903	□	OPT14		227	3	120	INV	R 600 a	WW	39
	1000 x 800 x 1120								230 50-60Hz		

S. Senza allestimento interno • Without inside fittings

OPT14 - Pag. 118



				 		 OFF		 ON	
59	0,9								
77									
69	0,9	+12 °C		+20 °C		+6 °C		+16 °C	
90		+8 °C		+14 °C		+4 °C		+14 °C	
79	0,9								
100									
69	0,9	+12 °C		+20 °C		+6 °C		+16 °C	
90		+6 °C		+14 °C		+4 °C		+14 °C	
79	0,9								
100									
71	0,9	+12 °C		+20 °C		+6 °C		+16 °C	
92		+6 °C		+14 °C		+4 °C		+14 °C	
81	0,9								
102									
59	0,9								
77									
66	0,9	+12 °C		+20 °C		+6 °C		+16 °C	
97		+8 °C		+14 °C		+4 °C		+14 °C	
76	0,9								
107									



Le temperature riportate sono indicative e possono variare di (+ -) 2 °C. Rilevazioni effettuate con temperatura ambiente di 25 °C.
 Reported temperatures are approximate and may vary by (+ -) 2 °C. Detections made in 25 °C ambient temperature.

Mod 20













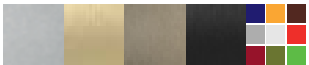

CODE	 mm L x P x H	 mm L x P x H		Pnom 	 KWh annum
 MD-H2-01	900 x 363 x 903	1000 x 800 x 1120	113	2 W	18
 MD-M2-01	900 x 515 x 903	1000 x 800 x 1120	222	4 W	35
 MD-C2-01	900 x 520 x 903	1000 x 800 x 1120	227	4 W	35
 MD-H2-02	486 x 363 x 903	600 x 800 x 1120	61	2 W	18
 MD-M2-02	486 x 515 x 903	600 x 800 x 1120	120	4 W	35
 MD-C2-02	486 x 520 x 903	600 x 800 x 1120	122	4 W	35
CODE	 L01	 L20 L21	 L10 L11 L30 L40 L42	 RAL*	
 MD-H2-30	●	●	●	●	
MD-M2-30	●	●	●	●	
MD-C2-30	●	●	●	●	
 MD-H2-31	●	●	●	●	
MD-M2-31	●	●	●	●	
MD-C2-31	●	●	●	●	

* I colori RAL vengono realizzati su supporto di MDF in finitura opaca 20 gloss.

* RAL colours are made on MDF 20-gloss matte finish.









						
	2	WW	100 - 240V	53	74	0,9
	2	WW	100 - 240V	61	82	0,9
	2	WW	100 - 240V	71	92	0,9
	1	WW	100 - 240V	28	49	0,6
	1	WW	100 - 240V	32	53	0,6
	1	WW	100 - 240V	37	58	0,6
						
900 x 350 x 903	1000 x 600 x 1120		59	72	0,7	
900 x 510 x 903	1000 x 600 x 1120		67	80	0,9	
900 x 510 x 903	1000 x 600 x 1120		65	78	0,9	
486 x 350 x 903	800 x 600 x 1120		35	46	0,6	
486 x 510 x 903	800 x 600 x 1120		39	50	0,6	
486 x 510 x 903	800 x 600 x 1120		37	48	0,6	

Finiture Mod 20

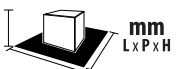
CODE		 L01	 A01	 M01	 L20 L21	 L22 L23	 L10 L11 L30 L40 L42	 L50 L51 L52 L53	 RAL *	 LM01 LM02
CORNICI • FRAMES										
		FN-CL1D	•	-	-	•		•		•
		FN-CL2D	•	-	-	•		•		•
		FN-CL3D	•	-	-	•		•		•
		FN-CL4D	•	-	-	•		•		•
		FN-CL5D	•	-	-	•		•		•
		FN-CL6D	•	-	-	•		•		•
		FN-CS1D	-	•	-	-		-		•
		FN-CS2D	-	•	-	-		-		•
		FN-CS3D	-	•	-	-		-		•
		FN-CS4D	-	•	-	-		-		•
		FN-CS5D	-	•	-	-		-		•
		FN-CS6D	-	•	-	-		-		•
RIVESTIMENTO FIT • Fit cladding										
		FN-RFH1D	•	-	-	•		•		-
		FN-RFM1D	•	-	-	•		•		-
		FN-RFC1D	•	-	-	•		•		-
		FN-RFH2D	•	-	-	•		•		-
		FN-RFM2D	•	-	-	•		•		-
		FN-RFC2D	•	-	-	•		•		-
		FN-RFH3D	•	-	-	•		•		-
		FN-RFM3D	•	-	-	•		•		-
		FN-RFC3D	•	-	-	•		•		-

* I colori RAL vengono realizzati su supporto di MDF in finitura opaca 20 gloss.

* RAL colours are made in MDF 20-gloss matte finish.

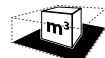
								
---	---	---	---	---	--	---	---	---

1013 X 1200 X 7	1320 X 600 X 100	1320 X 600 X 250	•	10	20	28	0,1	0,2
1013 X 2100 X 7	2250 X 600 X 100	2250 X 600 X 250	•	12	22	30	0,1	0,3
1013 X 3000 X 7	3120 X 600 X 100	3120 X 600 X 250	•	15	25	33	0,1	0,5
1013 X 3900 X 7	3120 X 600 X 100	3120 X 600 X 250	•	18	28	37	0,1	0,5
1013 X 4800 X 7	3120 X 600 X 100	3120 X 600 X 250	•	21	31	41	0,1	0,5
1013 X 5700 X 7	3120 X 600 X 100	3120 X 600 X 250	•	24	34	48	0,1	0,5
1013 X 1200 X 70	1320 X 600 X 150	1320 X 600 X 300	•	11	21	29	0,1	0,2
1013 X 2100 X 70	2250 X 600 X 150	2250 X 600 X 300	•	13	23	31	0,1	0,4
1013 X 3000 X 70	3120 X 600 X 150	3120 X 600 X 300	•	16	26	34	0,1	0,6
1013 X 3900 X 70	3120 X 600 X 150	3120 X 600 X 300	•	19	29	38	0,1	0,6
1013 X 4800 X 70	3120 X 600 X 150	3120 X 600 X 300	•	23	33	41	0,1	0,6
1013 X 5700 X 70	3120 X 600 X 300	3120 X 600 X 450	•	27	37	47	0,1	0,6

914 x 370 x 909	-	-		15	-	-	-	-
914 x 540 x 910	-	-		18	-	-	-	-
914 x 540 x 910	-	-		20	-	-	-	-
1814 x 370 x 909	-	-		21	-	-	-	-
1814 x 540 x 9150	-	-		25	-	-	-	-
1814 x 540 x 910	-	-		28	-	-	-	-
2714 x 370 x 909	-	-		27	-	-	-	-
2714 x 540 x 910	-	-		32	-	-	-	-
2714 x 540 x 910	-	-		37	-	-	-	-



CENTRAL COOLING SYSTEM (PATENTED)

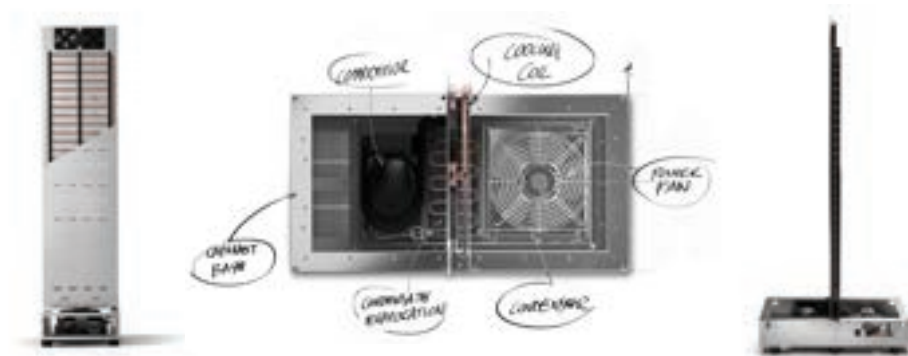

Rappresenta una rivoluzione nel campo della termodinamica applicata. È il primo frigorifero al mondo con serpentina di evaporazione al centro del vano refrigerato, un perfetto equilibrio termico.

L'evaporatore diventa un supporto. Tutte le bottiglie sono poste alla stessa distanza dalla fonte del freddo.

Si tratta di un'intuizione che ha aperto la strada ad una nuova concezione di progettazione e costruzione, capace di valorizzare nuovi volumi e creare inattese trasparenze.

A revolution in applied thermodynamics.

The first refrigerator in the world with an evaporation coil in the middle of the refrigerated compartment, a perfect thermal balance.

The evaporator becomes a support. All bottles are at the same distance from the source of cold.

An insight that paved the way to a new concept in design and construction, adding value to new volumes and creating unexpected transparencies.

Unità refrigerante integrata (standard)

IMPIANTO A REFRIGERAZIONE CENTRALE (brevettato) - condensazione ventilata

Installato su tutte le vetrine profondità (510 - 530 mm)

CENTRAL COOLING SYSTEM (patented) · Installed on all cabinets with (510 - 530 mm) depth

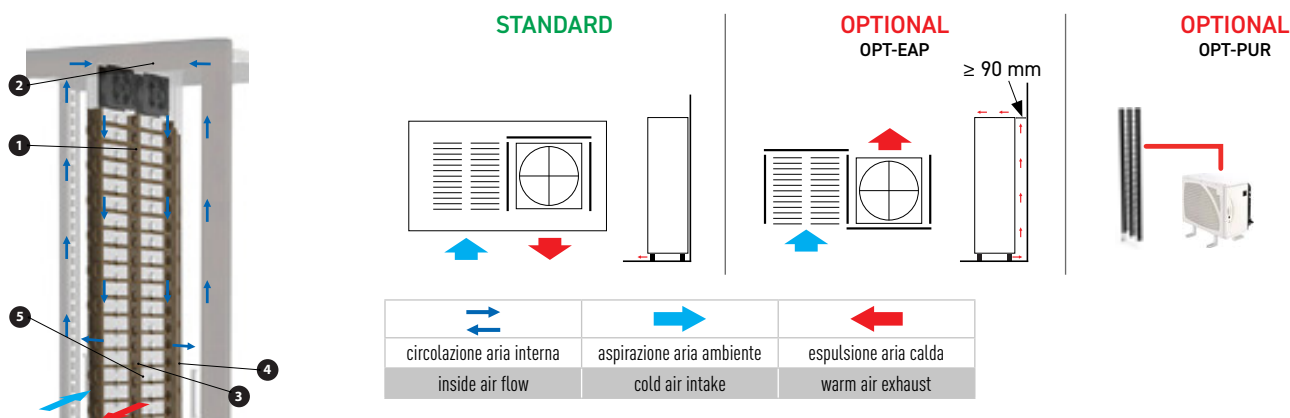

La serpentina di raffreddamento ❶ e le ventole di aereazione interna ❷ sono inserite al centro della vetrina all'interno dei pannelli di alluminio. Il compressore ❸, il condensatore orizzontale con ventola a pala premente ❹ e la vasca per l'evaporazione della condensa ❺ sono inseriti in una speciale vasca ribassata. Con questa soluzione, pur installando un compressore importante (1/4 hp), l'altezza della base è limitata (150 mm) in quanto viene utilizzato lo spazio inferiore dove sono inseriti i piedi (40 mm). La circolazione dell'aria di condensazione avviene dalla parte inferiore frontale.



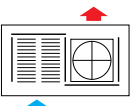

The cooling coil ❶ and the internal fans ❷ are installed in the middle of the cabinet inside the aluminium panels. The compressor ❸, the horizontal condensing unit, the pushing fan ❹ and the vat for the evaporation of the condensation water ❺ are placed in a special lowered tank. With this solution, despite installing a high power compressor (1/4 hp), the height of the base is limited (150 mm) as it takes up the lower space where feet are located (40 mm). Condensation air circulates from the bottom front part.

Espulsione aria posteriore · Air exhaust at rear

CODE	
 OPT-EAP	Inserimento di deflettori che convogliano l'aria calda nel lato posteriore. È necessario lasciare uno spazio di almeno 9 cm tra la vetrina ed il muro ed un'apertura nella parte superiore della vetrina che consenta l'espulsione dell'aria calda.

Unità remota silenziata (optional) SILENCED REMOTE UNIT (OPTION)

Predisposizione unità remota · Setting for remote compressor

 OPT-PUR	Le vetrine sono sprovviste di unità condensatrice. Tutte le vetrine vengono predisposte con valvola termostatica di serie. Le tubazioni per l'allacciamento alla linea frigorifera sono nella parte inferiore della vetrina. È necessario prevedere una linea di scarico per l'acqua di condensa e l'alimentazione elettrica.			
	CODE	N. modules	 mm L x P x H	
	GAS R134a			
	OPT-UR01-134	1	930 x 575 x 690	Tecumseh AE 4440 Y
	OPT-UR02-134	2	930 x 575 x 690	Tecumseh CAJ 4461 Y
	OPT-UR03-134	3	930 x 575 x 690	Tecumseh CAJ 4511 Y

Le potenze sono state calcolate per una linea frigorifera non superiore a 15 metri · Compressor power is calculated considering a distance not higher than 15 meters

IMPIANTO A REFRIGERAZIONE POSTERIORE - CONDENSAZIONE STATICA

Installato su tutte le vetrine profondità (350 - 362 mm)

REAR COOLING SYSTEM – static condensation • Installed on all cabinets with (350 - 362 mm) depth

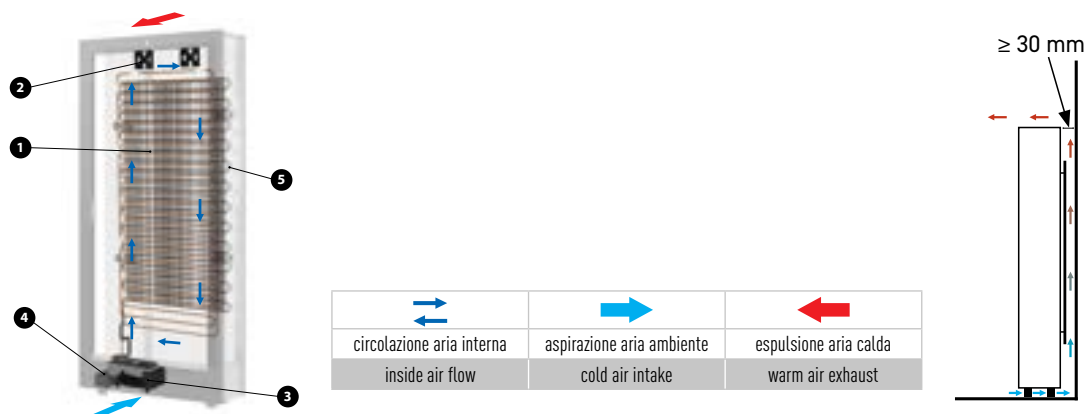

La serpentina di raffreddamento ❶ e le ventole di aereazione interna ❷ sono posizionate all'interno del vano refrigerato dietro il pannello posteriore in alluminio. Il compressore ad inverter ❸ e la vasca per l'evaporazione della condensa ❹ sono inseriti nella base inferiore. Il condensatore statico ❺ è installato nel retro della vetrina. Il raffreddamento del condensatore avviene per convezione senza l'ausilio di ventole. L'aria ambiente passa sotto la base e sale nello spazio tra il retro della vetrina ed il muro, si riscalda ed esce dall'alto.

The cooling coil ❶ and the internal aeration fans ❷ are placed inside the refrigerated compartment, behind the aluminum back panel. The inverter compressor ❸ and the evaporation pan ❹ are placed in the lower base. The static condenser ❺ is installed in the back of the cabinet. The condenser cools down due to convection without the use of fans. Ambient air comes through under the base and rises in the gap between the back of the cabinet and the wall, gets warm and exits from the top.

Insertion of deflectors which send the hot air to the back. A gap of at least 9 cm must be left between the cabinet and the rear wall and the corresponding top part must be left open to allow the expulsion of the hot air.

The units are provided without condensing unit. They are supplied with thermostatic valve as standard. The pipes for the connection to the refrigerating line are in the lower part of the unit. It is necessary to provide a discharge pipe for the condensing water and the power supply.

HP	HF					
				- 10 °C (TA 32)	mm L A	10 m - 5 m
1/3	R134a	230 / 1 / 50	504	611	1/4 - 3/8	27 - 33
1/2	R134a	230 / 1 / 50	667	882	1/4 - 1/2	28 - 34
1	R134a	230 / 1 / 50	1123	1670	3/8 - 5/8	30 - 36

EXPO CONNEX

Expo ConneX è un'applicazione per il monitoraggio ed il controllo wireless dei prodotti Della Marta.

L'app permette all'utente di usufruire dei servizi di report settimanale e di alert tramite messaggi push e via mail. È possibile controllare e modificare, anche a distanza ed in tempo reale, le temperature e le impostazioni delle vetrine. Grazie a questo sistema di connessione sempre attivo, la vetrina viene monitorata e consente di ricevere supporto tecnico, tramite diagnostica, in qualsiasi parte del mondo il prodotto si trovi.

L'applicazione Expo ConneX è disponibile su Play Store e App Store.

Expo ConneX is an app for wireless remote monitoring and control of Della Marta products.

This app allows the user to view weekly reports and receive push and email alerts. It allows to control and edit, remotely and in real time, temperature and settings of the cabinets. Thanks to this always-running connection system, the cabinet is monitored and remote technical support – through diagnostics – can be provided anywhere in the world.

Expo ConneX is available on the App Store and Play Store.















FILTRO A CARBONI ATTIVI

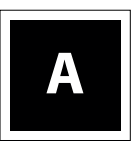

Cambiare spesso i carboni è importante per mantenere un corretto microclima all'interno della vetrina.
Il filtro a carboni attivi ricaricabile consente la facile sostituzione dei carboni senza dover necessariamente sostituire l'intero filtro.
I carboncini esausti possono essere conferiti nell'organico.
Una soluzione nel segno della massima sostenibilità ambientale.

*Changing carbons often is important to maintain an appropriate microclimate inside the cabinet.
Rechargeable activated carbon filter lets you easily swap carbons without necessarily changing the whole filter.
Exhausted carbons can be disposed of as organic waste.
A solution in the name of maximum environmental sustainability.*

Optional

CODE	DS	Disponibile <i>Available</i>	Non disponibile <i>Not available</i>
 OPT-TCR	Termoregolatore controllo remoto <i>Temperature control remote access</i>	Tutte le vetrine <i>All units</i>	Moduli B
 OPT-RGB-CX	Controller RGB <i>RGB controller</i>	Tutte le vetrine <i>All units</i>	Moduli B
 OPT-CBD-CX	Controller bianco dinamico <i>Dinamic white controller</i>	Tutte le vetrine <i>All units</i>	Moduli B
 OPT-RGB	Controller RGB <i>RGB controller</i>	Tutte le vetrine <i>All units</i>	-
 OPT-CBD	Controller bianco dinamico <i>Dinamic white controller</i>	Tutte le vetrine <i>All units</i>	-
 OPT-VFS	Voltaggio/frequenza speciali (115V / 60Hz) <i>Special voltage/frequency (115V / 60hz)</i>	Tutte le vetrine <i>All units</i>	-
 OPT-ABK	All black	Tutte le vetrine <i>All units</i>	-
 OPT-PCN	Porte colore Nero <i>Black doors</i>	Tutte le vetrine <i>All units</i>	-
 OPT-RIS	Rivestimento specchio <i>Mirror panel</i>	Tutte le vetrine M / C <i>All M / C units</i>	Moduli B Vetrine H <i>H units</i>
 OPT-FCA	Filtro a carboni attivi <i>Activated carbon filter</i>	Tutte le vetrine <i>All units</i>	Moduli B
Model Reg. n. TO 20 2016 0000 92512  OPT-V1	Vaschetta acciaio inox <i>Stainless steel tray</i>	Tutte le vetrine <i>All units</i>	-

<p>Controllabile da remoto tramite App dedicata. Consente l'assistenza e supporto da remoto. Permette l'ottenimento dei benefici fiscali previsti dal piano Transizione 4.0.</p>	<p><i>Remote control with dedicated app. Allows remote support and assistance.</i></p>
<p>Installazione impianto led RGB (60 led/m - 14,4 Wm - 24 V) in sostituzione dei led bianchi standard. Gestione tramite app Expo Connex collegandosi in wi-fi sul proprio router. Il colore bianco dei led RGB è bianco freddo (6.000-6.500 K). *Utilizzabile solo in abbinamento ad OPT-TCR.</p>	<p><i>Replaces standard white LEDs with RGB LEDs (30 led/m - 7,2 Wm - 550 lumen/m - 12 V). Manage with Expo Connex app by connecting through wi-fi router. White hue on RGB LEDs is cold white (6000-6500°K). *Only available if paired with OPT-TCR.</i></p>
<p>Installazione impianto led BIANCO DINAMICO (140 led/m - 19,2 Wm - 2.000 lumen/m - 24 V) in sostituzione dei led bianchi standard. Gestione tramite app Expo Connex collegandosi in wi-fi sul proprio router (variabile da bianco caldo 2700 K a bianco freddo 6000 K). Controllo intensità luminosa. *Utilizzabile solo in abbinamento ad OPT-TCR.</p>	<p><i>Replaces standard white LEDs with DYNAMIC WHITE LED system (140 led/m - 19,2 Wm - 2.000 lumen/m - 24 V). Manage with Expo Connex app by connecting through wi-fi router (adjustable from warm white 2700°K to cold white 6000°K). Includes dimmer setting. *Only available if paired with OPT-TCR.</i></p>
<p>Installazione impianto led RGB (30 led/m - 7,2 Wm - 550 lumen/m - 12 V) in sostituzione dei led bianchi standard. Telecomando per gestione colori, programmazione effetti ed intensità luminosa. Il colore bianco dei led RGB è bianco freddo (6.000-6.500 K).</p>	<p><i>Replaces standard white LEDs with RGB LEDs. Various colours, lighting effects and dimming can be selected with the included remote control. RGB's white hue is very cool (6000-6500°K). We suggest not using the RGB LEDs for cold dish and cured meats/cheese units.</i></p>
<p>Installazione impianto led BIANCO DINAMICO (140 led/m - 19,2 Wm - 2.000 lumen/m - 24 V) in sostituzione dei led bianchi standard. Telecomando per gestione colore bianco (variabile da bianco caldo 2700 K a bianco freddo 6000 K). Controllo intensità luminosa.</p>	<p><i>Installation of DYNAMIC WHITE (140 led/m - 19,2 Wm - 2.000 lumen/m - 24 V) setup in place of standard white LEDs. Remote control for white setting (ranging from warm white 2700 K to cold white 6000 K). Dimmer.</i></p>
<p>Installazione di Impianto frigorifero e parti elettriche accessorie con voltaggio frequenza speciali. Le versioni disponibili sono: 115 V - 60 Hz. Le vetrine a voltaggio 115 V sono state testate in base alla normativa UL per cui possono essere fornite con marchio ETL.</p>	<p><i>Installation of cooling system and added electrical parts with special voltage and frequency. Available setups are: 115 V - 60 Hz. Cabinets with 115 V systems have been tested in compliance to UL standards and therefore can be supplied with ETL mark.</i></p>
<p>Verniciatura a polveri epossidiche colore nero opaco di tutte le parti metalliche interne (montanti, pannelli interni, accessori, piano) ed esterne (profili porte, telai, maniglie, carter). A seconda dei modelli, alcuni particolari tipo viti o reggimensole vengono mantenuti in finitura inox.</p>	<p><i>Black matte epoxy powder coating of all internal (beams, internal panels, accessories, shelf) and external (door profiles, frame, handles, flank) metal parts. Depending on model, some details i.e. screw caps or shelf supports remain in stainless steel finish.</i></p>
<p>Verniciatura a polveri epossidiche colore Nero della parte esterna. MOD (profili porte, telaio di battuta delle porte, maniglie) TECA (profili porte maniglie).</p>	<p><i>Black epoxy powder coating of the external part. MOD (door profile, frame, handles) TECA (door profile, handle).</i></p>
<p>Sostituzione del rivestimento interno standard in alluminio anodizzato con un rivestimento in alluminio specchio. A secondo dei modelli, si può inserire il rivestimento a specchio nelle spalle laterali e nella schiena.</p>	<p><i>Replaces the standard anodized aluminium lining with an aluminium mirror coating. Depending on the model, it applies to side and back panels.</i></p>
<p>Filtro a carboni attivi ricaricabile. È possibile estrarre il filtro dalla vetrina e sostituire i carboni in pochi minuti. Permette un naturale ricircolo di aria nelle vetrine vino. È consigliato per le vetrine utilizzate per conservazione che non vengono aperte spesso.</p>	<p><i>Rechargeable activated carbon filter. The filter can be easily removed from the cabinet to quickly replace the coals. It allows a natural circulation of air in the wine showcase. This option is suggested for the showcases used for conservation that are not frequently opened.</i></p>
<p>Vaschetta in acciaio inox lucido con bordi piegati a 45 gradi, dim. L x P x H mm 171 x 195 x 15. È possibile posizionare 4 vaschette sia sul piano in vetro da mm 350 x 400 (cioccolato - gastronomia) che sul piano mm 340 x 400 (salumeria). Consente di ottimizzare lo spazio sul piano in tutte le vetrine cioccolato, gastronomia e salumeria.</p>	<p><i>Polished stainless steel tray with edges bent at 45 degrees, dim. W x D x H 171 x 195 x 15 mm. Up to 4 trays fit on each glass shelf 350 x 400 mm (chocolate - cold dishes) as well as on 340 x 400 mm shelves (cured meats/cheese). Useful to make the most of the available space for chocolate, cold dish and cured meats/cheese units.</i></p>

Optional

	CODE	CODE 		
OPTIONAL MOD - TECA *14 - 24 (M / C)				
	OPT-14MP-BF	OPT-14MP-BF-NR	Bottiglie frontali (Mod)	<i>Front neck bottles (Mod)</i>
	OPT-14T-BF	OPT-14T-BF-NR	Bottiglie frontali (Teca)	<i>Front neck bottles (Teca)</i>
	OPT-14MP-BF-3	OPT-14MP-BF-3-NR	Bottiglie frontali (Mod)	<i>Front neck bottles (Mod)</i>
	OPT-14T-BF-3	OPT-14T-BF-3-NR	Bottiglie frontali (Teca)	<i>Front neck bottles (Teca)</i>
	OPT-14MP-BI	OPT-14MP-BI-NR	Bottiglie inclinate (Mod)	<i>Reclined bottles (Mod)</i>
	OPT-14T-BI	OPT-14T-BI-NR	Bottiglie inclinate (Teca)	<i>Reclined bottles (Teca)</i>
	OPT-14-B0	OPT-14-B0-NR	Bottiglie orizzontali (Mod - Teca)	<i>Horizontal bottles (Mod - Teca)</i>
	OPT-14MP-PR	OPT-14MP-PR-NR	Piano regolabile (Mod)	<i>Adjustable shelf (Mod)</i>
	OPT-14T-PR	OPT-14T-PR-NR	Piano regolabile (Teca)	<i>Adjustable shelf (Teca)</i>
OPTIONAL MOD - TECA *14 - 24 (H)				
	OPT-14MPH-BI	OPT-14MPH-BI-NR	Bottiglie inclinate (Mod)	<i>Reclined bottles (Mod)</i>
	OPT-14TH-BI	OPT-14TH-BI-NR	Bottiglie inclinate (Teca)	<i>Reclined bottles (Teca)</i>
	OPT-14MPH-BI-3	OPT-14MPH-BI-3-NR	Bottiglie inclinate (Mod)	<i>Reclined bottles (Mod)</i>
	OPT-14TH-BI-3	OPT-14TH-BI-3-NR	Bottiglie inclinate (Teca)	<i>Reclined bottles (Teca)</i>
	OPT-14H-B0	OPT-14H-B0-NR	Bottiglie orizzontali (Mod - Teca)	<i>Horizontal bottles (Mod - Teca)</i>
	OPT-14MPH-PR	OPT-14MPH-PR-NR	Piano regolabile (Mod)	<i>Adjustable shelf (Mod)</i>
	OPT-14TH-PR	OPT-14TH-PR-NR	Piano regolabile (Teca)	<i>Adjustable shelf (Teca)</i>
OPTIONAL MOD - TECA *14 - 24 - KIT STANDARD				
	OPT-14MPH-KC	OPT-14MPH-KC-NR	Kit standard (Mod H)	<i>Kit standard (Mod H)</i>
	OPT-14MP-KC	OPT-14MP-KC-NR	Kit standard (Mod)	<i>Kit standard (Mod)</i>
	OPT-14TH-KC	OPT-14TH-KC-NR	Kit standard (Teca H)	<i>Kit standard (Teca H)</i>
	OPT-14T-KC	OPT-14T-KC-NR	Kit standard (Teca)	<i>Kit standard (Teca)</i>

Le vetrine *14 - 24 della serie Teca e Mod vengono fornite senza allestimenti.
È possibile personalizzare l'allestimento interno scegliendo uno o più optional tra quelli sopra indicati.

Piano in plexiglas con staffette di fissaggio. Il sistema è regolabile in altezza con passo di 5 cm in funzione delle bottiglie inserite. Ogni piano può contenere 4 bottiglie. Diametro massimo bottiglie 85 mm, altezza massima 360 mm.	<i>Plexiglas shelf with fixing brackets. The system is adjustable in height, shelves can be fitted every 5 cm. depending on how many and what kind of bottles you want to insert. Each shelf can hold 4 bottles.</i>
Piano in plexiglas con staffette di fissaggio. Il sistema è regolabile in altezza con passo di 5 cm in funzione delle bottiglie inserite. Ogni piano può contenere 3 bottiglie Magnum. Diametro massimo bottiglie 120 mm, altezza massima 400 mm.	<i>Perspex shelf with mounting brackets. The system is adjustable in height, shelves can be fitted every 5 cm. depending on how many and what kind of bottles you want to insert. Each shelf can hold 3 Magnum bottles.</i>
Struttura realizzata con laterali in plexiglas e tondini in alluminio. Questa struttura può essere posizionata a diverse altezze con interasse minimo di 20 cm. Può contenere fino 7 bottiglie classiche da 0.75 l oppure 4 Magnum ø 110 mm. Possibilità di installare 8 display (14) e 3 display (24) per ciascun vano. Diametro massimo bottiglie 95 mm, altezza massima 350 mm.	<i>Structure made of Plexiglas sides and aluminium rods. This structure can be positioned at different heights, with a minimum gap of 20 cm. It can hold 7 standard 0.75 l. bottles or 4 Magnum ø 110 mm. Up to 8 displays (14) and 3 displays (24) can be installed in each compartment.</i>
3 Kit composti da 8 tondini cadauno (totale 24 tondini). Con ogni kit è possibile esporre 3 file da 8 bottiglie (24 bottiglie totali) ed è regolabile in altezza ogni 10 cm. Diametro massimo bottiglie 90 mm, altezza massima 320 mm (Teca) 360 mm (Mod).	<i>3 kits made of 8 rods each (24 rods in total). Each kit stores 3 rows of 8 bottles (24 bottles total) and can be adjusted every 10cm in height.</i>
Piano regolabile in vetro temperato con reggi mensole. Il piano è regolabile con passo 5 cm. È molto utile per il posizionamento di bottiglie in verticale, bottiglie e decanter.	<i>The shelves can be positioned every 5 cm. Suitable for vertical bottles, glasses and decanters.</i>
Piano in plexiglass termoformato. Questo accessorio può essere posizionato a diverse altezze e può contenere 4 bottiglie classiche da 0,75 l. Possibilità di installare 5 display (14) e 3 display (24) per ciascun vano. Diametro massimo bottiglie 80 mm, altezza massima 350 mm.	<i>Thermoformed plexiglass support. This component can be positioned at different heights and can contain 4 classic 0.75 l bottles. Up to 5 displays (14) and 3 displays (24) can be installed in each compartment.</i>
Piano in plexiglass termoformato. Questo accessorio può essere posizionato a diverse altezze e può contenere 3 bottiglie da 0.75 cl. Diametro massimo bottiglie 100 mm, altezza massima 350 mm.	<i>Thermoformed plexiglass ledge. This component can be positioned at different heights and can contain 3 0.75 l bottles.</i>
4 Kit composti da 4 tondini cadauno (totale 16 tondini). Con un kit è possibile esporre 4 file da 4 bottiglie (16 bottiglie totali) ed è regolabile in altezza ogni 10 cm. Diametro massimo bottiglie 90 mm, altezza massima 320 mm (Teca) 360 mm (Mod).	<i>4 kits made of 4 rods each (16 rods in total). Each kit stores 4 rows of 4 bottles (16 bottles total) and can be adjusted every 10 cm in height.</i>
Piano regolabile in vetro temperato con reggi mensole. Il piano è regolabile con passo 5 cm. È molto utile per il posizionamento di bottiglie in verticale e bicchieri.	<i>The shelves can be positioned every 5 cm. Suitable for vertical bottles, glasses and decanters.</i>
Kit standard allestimento interno vetrine Mod H. Comprende n. 2 OPT-14MPH-BI - n. 1 OPT-14H-BO - n. 3 OPT-14MPH-PR	<i>Standard interior setup for Mod H cabinets. Includes n. 2 OPT-14MPH-BI - n. 1 OPT-14H-BO - n. 3 OPT-14MPH-PR</i>
Kit standard allestimento interno vetrine Mod. Comprende n. 5 OPT-14MP-BF n. 3 OPT-14MP-BI - n. 2 OPT-14MP-PR - n. 1 OPT-14-BO	<i>Standard interior setup for Mod cabinets. Includes n. 5 OPT-14MP-BF - n. 3 OPT-14MP-BI - n. 2 OPT-14MP-PR - n. 1 OPT-14-BO</i>
Kit standard allestimento interno vetrine Teca H. Comprende n. 2 OPT-14TH-BI - n. 1 OPT-14H-BO - n. 3 OPT-14TH-PR	<i>Standard interior setup for Teca H cabinets. Includes n. 2 OPT-14TH-BI - n. 1 OPT-14H-BO - n. 3 OPT-14TH-PR</i>
Kit standard allestimento interno vetrine Teca. Comprende n. 5 OPT-14T-BF n. 3 OPT-14T-BI - n. 2 OPT-14T-PR - n. 1 OPT-14-BO	<i>Standard interior setup for Teca cabinets. Includes n. 5 OPT-14T-BF - n. 3 OPT-14T-BI - n. 2 OPT-14T-PR - n. 1 OPT-14-BO</i>

The units * 14 - 24 of the Teca and Mod series are supplied without internal fittings. You can customize the interior by choosing one or more of the options above.

Arka

Sistema componibile. È possibile disporre i diversi moduli nella posizione desiderata ad eccezione del modulo (AK-MD1000) e delle basi e pensili Tv che devono essere posizionati tra due altri moduli. Possono essere inserite le vetrine vino delle collezioni Teca e Mod utilizzando i diversi moduli progettati per questa applicazione.

Modular system. Modules can be installed in the desired position except for (AK-MD1000) module, and TV supports which are to be positioned between two other modules. Cabinets from the Mod and Teca collections can be integrated using the different modules designed for this application.

Installazione della vetrina vino

Ways of installing the wine cabinet • Type d'installation de la vitrine



Teca B (TE-BH10 / TE-BH14)



Mod (MD-H10 / MDH14)
con cornice • with frame
(MD-CS / MD-CL)



Mod (MD-H10 / MDH14)
a filo • flush

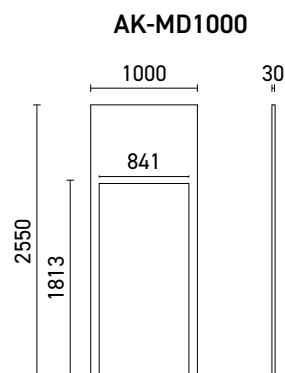
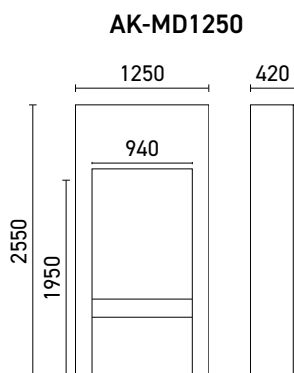
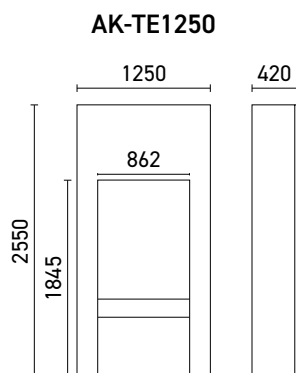

Per installare nel Wine Living Zero uno dei modelli della vetrina Teca B occorre inserire il modulo del living AK-TE1250. La vetrina viene incassata mentre la cornice rimane esterna in battuta.

To install one of the Teca B models in Wine Living Zero, insert the living module AK-TE1250.

The display case stays recessed while the frame stays outside in contact.

Inserendo nel living il modulo AK-MD1250 è possibile installare uno dei modelli della collezione MOD 10 series sia con cornice lineare che sagomata. La cornice rimane esterna.

By inserting the AK-MD1250 module into the living room, one of the series MOD 10 unit can be installed with either a linear or a shaped frame. The frame remains external.

Per realizzare l'installazione a filo occorre scegliere una vetrina della collezione MOD 10 series ed inserire nel mobile living il modulo AK-MD1000. La vetrina viene incassata mentre il rivestimento viene applicato in modo magnetico.

To realize a flush installation, choose a showcase from the MOD10 collection and insert the AK-MD1000 module into the living room furniture. The display stay recessed while the framing is magnetically applied.

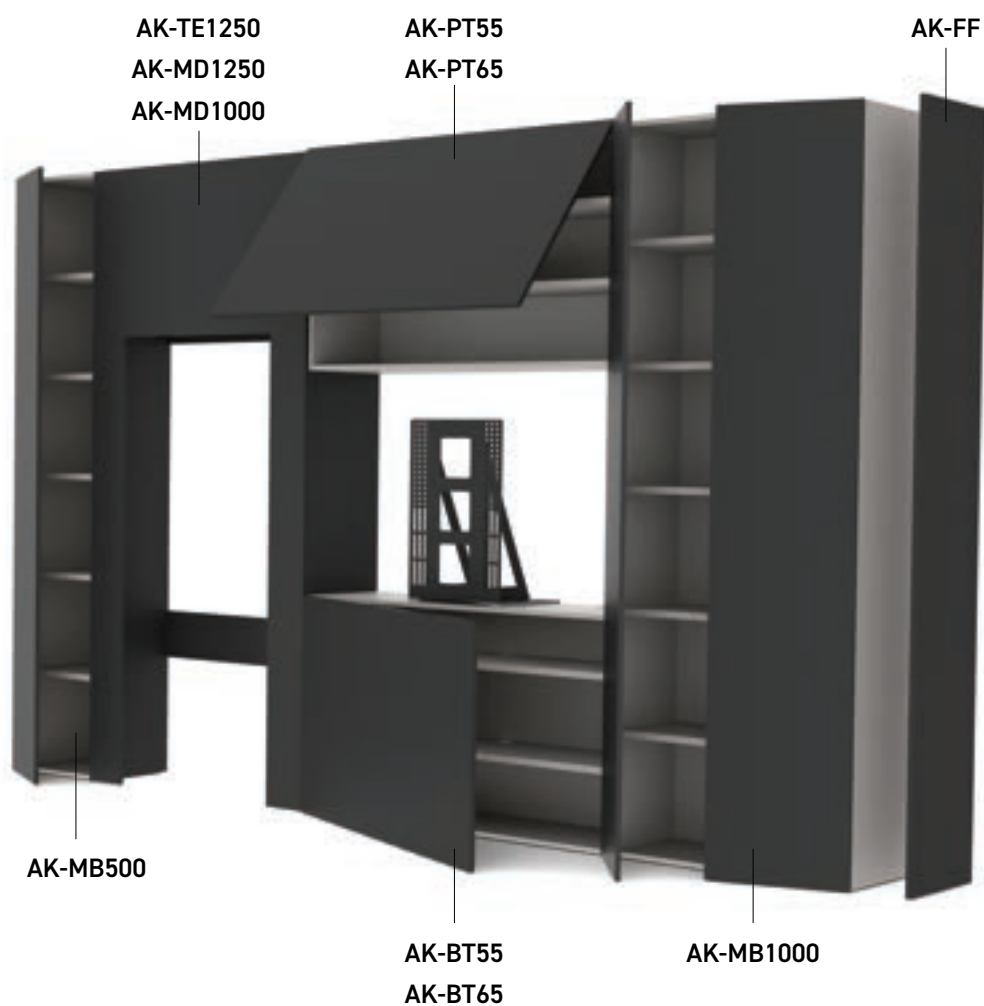

CARATTERISTICHE COSTRUTTIVE

Features

Struttura in nobilitato
Anta in MDF laccato
Piani regolabili
Chiusura delle ante rallentata
Piedini regolabili
Staffa supporto/estrazione TV in metallo con guide estraibili.

*Faced panel structure
Doors in lacquered finish MDF
Adjustable shelves
Soft close doors
Adjustable feet
Metal TV bracket support with pull-out rails.*





Arka

CODE	 RAL 9010 RAL 9005 RAL*	 mm LxPxH	 mm LxPxH
 AK-MB500	QP	500 x 420 x 2550	-
 AK-MB1000	QP	1000 x 420 x 2550	-
 AK-BT55	QP	1270 x 420 x 900	1400 x 600 x 1200
 AK-BT65	QP	1480 x 420 x 840	1600 x 600 x 1200
 AK-PT55	QP	1270 x 420 x 900	1400 x 600 x 1200
 AK-PT65	QP	1480 x 420 x 840	1600 x 600 x 1200
 AK-FF	QP	-	-
 AK-TE1250	QP	1250 x 420 x 2550	-
 AK-MD1250	QP	1250 x 420 x 2550	-
 AK-MD1000	QP	1000 x 30 x 2550	-

QP. Quotazione a progetto · Project quotation

* I colori RAL vengono realizzati su supporto di MDF in finitura opaca 20 gloss.

* RAL colours are made on MDF 20-gloss matte finish.

 n.	 Kg		 m³
6	82	-	0,3
8	124	-	0,4
1	73	89	1,1
1	82	98	1,2
1	68	84	1,1
1	87	103	1,2
1	-	-	0,1
4	49	-	0,3
4	47	-	0,3
2	12	-	0,2

COLORS

HPL laminato alta pressione · High pressure laminate

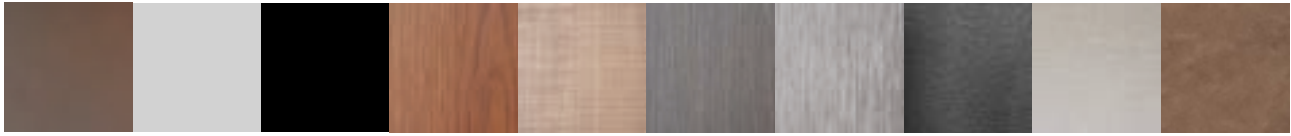

- L01**
HPL grezzo
raw HPL
- L10**
bianco opaco
matte white
- L11**
nero opaco
matte black
- L20**
castagno
chestnut
- L21**
Teak Roble
Teak Roble
- L22**
wengé loft
loft wenge
- L23**
larice cenere
ash larch
- L30**
nero materico
textured black
- L40**
cemento tortora
dove concrete
- L42**
corten
corten



- L50**
acciaio satinato
brushed steel
- L51**
oro satinato
satin gold
- L52**
bronzo satinato
satin bronze
- L53**
nero satinato
satin black

MDF Ayous Verniciatura a liquido · Liquid paint finish



- M01**
MDF non verniciato
no finish MDF
- A01**
ayous non verniciato
no finish ayous
- LM01**
oro metallico liquido
liquid metal gold
- LM02**
argento metallico liquido
liquid metal silver
- RAL 9010**
bianco opaco
matte white
- RAL 9005**
nero opaco
matte black
- RAL 20**
opaco 20 gloss
matte 20 gloss

Dune Verniciatura a liquido · Liquid paint finish



- D01**
Dune non verniciato
no finish Dune
- DLM01**
oro metallico liquido
liquid metal gold
- DLM02**
argento metallico liquido
liquid metal silver
- DRAL 9010**
bianco opaco (20 gloss)
matte white (20 gloss)
- DRAL 9005**
nero opaco (20 gloss)
matte black (20 gloss)
- DRAL 20**
opaco
matte

Classica Verniciatura a liquido · Liquid paint finish



- C01**
non verniciata
no finish Classic
- CLM01**
oro metallico liquido
liquid metal gold
- CLM02**
argento metallico liquido
liquid metal silver
- CRAL 9010**
bianco opaco (20 gloss)
matte white (20 gloss)
- CRAL 9005**
nero opaco (20 gloss)
matte black (20 gloss)
- CRAL 20**
opaco
matte

Ecopelle · Faux leather



- E10**
ecopelle bianca
white faux leather
- E11**
ecopelle nera
black faux leather
- E12**
ecopelle grigia
grey faux leather
- E13**
ecopelle rossa
red faux leather
- E39**
ecopelle pitone rosso
red python faux leather
- E40**
ecopelle rettile nera
black faux reptile leather
- E41**
ecopelle rettile blu
blue faux reptile leather
- E50**
ecopelle intrecciata tabacco
tobacco woven faux leather

Sughero · Cork

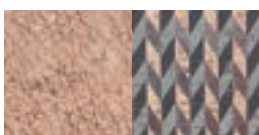

- E30**
sughero rete
cork mesh
- E31**
sughero spina di pesce
cork herringbone

Nobilitato



- N10**
grigio
grey



Colorazioni speciali RAL • *Special RAL colors*



RAL 1001 BEIGE **RAL 1002** SAND YELLOW **RAL 1003** SIGNAL YELLOW **RAL 1006** MAIZE YELLOW **RAL 1007** DAFFODIL YELLOW **RAL 1011** BROWN BEIGE **RAL 1014** IVORY **RAL 1015** LIGHT IVORY **RAL1019** GREY BEIGE **RAL 1024** OCHRE YELLOW



RAL 1034 PASTEL YELLOW **RAL 2000** YELLOW ORANGE **RAL 2003** PASTEL ORANGE **RAL 2010** SIGNAL ORANGE **RAL 3004** PURPLE RED **RAL 3005** WINE RED **RAL 3007** BLACH RED **RAL 3009** OXIDE RED **RAL 3012** BEIGE RED **RAL 3017** ROSE



RAL 3031 ORIENT RED **RAL 4001** RED LILAC **RAL 4004** CLARET VIOLET **RAL 4009** PASTEL VIOLET **RAL 5003** SAPPHIRE BLUE **RAL 5004** BLACK BLUE **RAL 5005** SIGNAL BLUE **RAL 5008** GREY BLUE **RAL 5012** LIGHT BLUE **RAL 5014** PIGEON BLUE



RAL 5020 OCEAN BLUE **RAL 6005** MOSS GREEN **RAL 6011** RESEDA GREEN **RAL 6019** PASTEL GREEN **RAL 7000** SQUIRREL GREY **RAL 7001** SILVER GREY **RAL 7003** MOSS GREY **RAL 7004** SIGNAL GREY **RAL 7006** BEIGE GREY **RAL 7011** IRON GREY

















RAL 7030 STONE GREY **RAL 7032** PEBBLE GREY **RAL 7035** LIGHT GREY **RAL 7036** PLATINUM GREY **RAL 7042** TRAFFIC GREY A **RAL 8002** SIGNAL BROWN **RAL 8007** FAWN BROWN **RAL 8014** SEPIA BROWN **RAL 8017** CHOCOLATE BROWN **RAL 8019** GREY BROWN















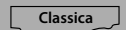







RAL 8022 BLACK BROWN **RAL 8025** PALE BROWN **RAL 8028** TERRA BROWN **RAL 9001** CREAM **RAL 9002** GREY WHITE **RAL 9003** SIGNAL WHITE **RAL 9004** SIGNAL BLACK **RAL 9005** JET BLACK **RAL 9010** PURE WHITE **RAL 9016** TRAFFIC WHITE

I colori stampati in questa cartella sono indicativi
The colours printed and shown in this folder are merely indicative

Legenda Legend

CODE	Codice	Code
	Temperatura (Temperatura interna vano refrigerato)	Temperature (Internal temperature in refrigerated compartment)
	Temperatura ambiente (Umidità relativa 50%)	Ambient temperature (Relative humidity 50%)
	Versione	Versio n
	Refrigerato	Cooled
	Neutro	Neutral
	Riscaldato	Heated
	Ventole interne spente	Internal fans off
	Ventole interne accese	Internal fans on
	Rumorosità - Pressione acustica Leq (h 155 cm - d. 100 cm)	Noise level - Leq sound pressure level (h 155 cm - d. 100 cm)
	Tensione	Voltage
	Assorbimento	Absorption
Class	Classe climatica	Climate class
	Modello/tipologia compressore	Compressor type
INV	Compressore inverter	Inverter compressor
FIX	Compressore a giri fissi	Fixed-speed compressor
HF	Gas refrigerante	Refrigerant gas
	Quantità gas	Gas amount
	Numero piastre eutettiche	Number of eutectic plates
LIGHT	Luce	Light
NW	Led bianco naturale (4000 K - 60 led/mt - 4,8 W / mt - 416 lumen / mt - 12V)	White natural daylight LED (4000 K - 60 led/mt - 4,8 W / mt - 416 lumen / mt - 12V)
WW	Led bianco caldo (3000 K - 60 led/mt - 1,2 W / mt - 130 lumen / mt - 12V)	brightwhite warm LED (3000 K - 60 led/mt - 1,2 W / mt - 130 lumen / mt - 12V)
BL	Led blu	Blue LED
RGB	Controller RGB (60 led/mt - 14,4 W / mt - 24V)	RGB controller (60 led/mt - 14,4 W / mt - 24V)
CCT	Controller bianco dinamico (2700/6000 K - 140 led/mt - 19,2 W / mt - 2000 lumen / mt)	Dinamic white controller (2700/6000 K - 140 led/mt - 19,2 W / mt - 2000 lumen / mt)



	Cornice lineare	Linear frame
	Cornice Dune	Dune frame
	Cornice Classica	Classic frame
	Lato posteriore vetrina	Showcase back side
	Ante in vetro	Glass doors
	Pannello cieco	Blank panel
 0,75 LT	Numero bottiglie	Number of bottles
 H ∅	Altezza / diametro bottiglie	Bottle height / diameter
	Presente	Present
-	Assente / dato non disponibile	Absent / data not available
 LT	Volume interno	Internal volume
 mm LxPxH	Dimensioni nette	Net dimensions
 mm LxPxH	Dimensioni con imballo	Dimensions including packaging
 mm LxPxH	Dimensioni con imballo su pedana	Dimensions including packing on pallet
 Kg	Peso netto	Net weight
 Kg	Peso con imballo	Weight with packaging
 Kg	Peso con imballo su pedana	Weight with packing on pallet
 m ³	Volume con imballo	Volume with packaging
 m ³	Volume con imballo su pedana	Volume with packaging on pallet
	Imballo in legno	Wooden packaging
DS	Descrizione	Description
 mm	Dimensione ventola	Fan blade size
 mm L A	∅ mm - Connessioni (liquido - aspirazione)	∅ mm - Connections (liquid - suction)



DELLA MARTA

Factory: Via G. Di Vittorio, 11 · 10098 Rivoli (TO) · ITALY

Flagship store: Via Pietro Maroncelli, 5 · 20154 Milano · ITALY

www.dellamarta.it · info@dellamarta.it

